

SONIC-PRO

Hybrid Ultrasonic Flowmeter



Installation and Operating Manual



ProSeriesTM
by Blue-White Ind.

Table of Contents

	Safety precautions	4
1	Product overview	5
	1.1 Operating principles	5
	1.2 Transit Time operation	5
	1.3 Doppler operation	6
	1.4 Fluid requirements	7
	1.5 Pipe requirements	7
	1.5 Straight pipe length requirements	7
	1.7 Standard model features and options	8
	1.8 Wiring compartment	9
2	Quick Start Guide	10
3	Flowmeter SPU installation	16
	3.1 Unpacking	16
	3.2 Select a mounting location	16
	3.3 Wall mounting	16
	3.4 Panel mounting	17
	3.5 Pipe mounting	17
	3.6 Select a measurement method	18
	3.7 Electrical connections	18
	3.8 Cable gland liquid tight connections	19
4	Overview of Flowmeter Operation	20
	4.1 Power on and self test	21
	4.2 Description of operating states and controls	21
	4.3 Startup state	22
	4.4 Setup (configuration) mode	22
	4.5 Transducer positioning state	23
	4.6 Zero calibration state	24
	4.7 Run mode	25
	4.8 Fault and warning codes	25
5	Setup mode	27
	5.1 Menu Navigation	27
	5.1.1 Setup root menu	27
	5.1.2 Escaping from setup	27
	5.2 Global configurations	28
	5.2.1 Communication settings	28
	5.2.2 Master password	29
	5.2.3 Setting the date and time	29
	5.2.4 Saving changes	29
	5.3 Manage configuration sets	30
	5.3.1 Activate a configuration set	30
	5.3.2 Open a saved configuration set	30
	5.3.3 Create a new configuration set	30
	5.3.4 Delete a saved configuration set	30
	5.4 Configuration edit menu	31
	5.4.1 Editing data items	31
	5.4.1.1 . Editing numerical values	31
	5.4.1.2 . Entering passwords using the soft buttons	32
	5.4.1.3 . Units of measure	32
	5.4.2 Transducer setup	33
	5.4.3 Metering setup	34
	5.4.4 Process control setup	37
	5.5.5 Reset working set to factory values	39
	5.4.6 Set password (for a single configuration set)	39
	5.4.7 Saving changes	39
	5.4.8 Escape without saving	39
6	Transducer installation	40
	6.1 Transducer piping system location	40
	6.2 Transducer mounting mode for Doppler measurement	40
	6.3 Transducer mounting mode for Transit Time measurement	40
	6.4 Transducer separation distance	41
	6.5 Pipe surface preparation	42
	6.6 Doppler method transducer installation	42
	6.7 Transit Time transducer installation - V and W mount mode	43

6.8	Transit Time transducer installation - Z mount mode	44
6.9	Transducer acoustic mounting gaskets	46
6.10	Transducer pipe mounting clamps	47
7	Run mode	48
7.1	Primary and secondary display areas	48
7.1.1	Flow rate measurement	49
7.1.2	Total flow measurement	50
7.2	Measurement status areas	50
7.2.1	Configuration and mode	50
7.2.2	Goodness of measurement	50
7.2.3	Sound speed display	51
7.2.4	Measuring the fluid sound speed	51
7.3	Process control status areas	52
7.4	Soft buttons	52
7.5	Output signals	52
7.5.1	Analog signal output	52
7.5.2	Digital pulse output	53
7.6	Data logging	53
7.6.1	Periodic logging	53
7.6.2	Logging rate setpoints	53
7.6.3	Logging totalizer setpoints	53
7.6.4	Local log data storage (SD flash memory card)	54
7.6.4.1	. Inserting and removing the memory card	54
7.6.4.2	. Format of data on the memory card	54
7.6.4.3	. Rotation and purging of log files	54
7.6.4.4	. Power loss	55
7.6.5	Remote access to log data	55
8	Process control	56
8.1	Process controlsScreen	56
8.2	Batch dispensing	57
8.2.1	Manual batch start type	57
8.2.2	Auto batch start type	58
8.2.3	Batch clear	59
8.2.4	Batch edit	59
8.3	Flow rate alarms	60
8.3.1	Basic operation	60
8.3.2	Clearing alarms	61
8.3.3	Editing alarms	61
8.3.4	More on clearing alarm conditions	62
9	Sonic-Pro User PC Software	63
9.1	Software installation	63
9.2	Making connections	63
9.2.1	Ethernet Connection	63
9.2.2	Serial and USB connections	64
9.3	Retrieving log data	64
10	Indexes	66
10.1	Complete flowmeter model number system	66
10.2	Additional transducers model number system	66
10.3	Specifications	67
10.4	Pipe dimensional data	68
10.5	Sound speed data	70
10.6	Troubleshooting guide	71

Safety Precautions

Thank you for purchasing the Sonic-Pro ultrasonic flowmeter.

This instruction manual provides important information regarding the safe installation, operation and maintenance of the flowmeter. Please read it carefully before attempting to install or operate the meter. A copy of this manual should be kept by the operator. Extra copies of this manual are available from your supplier or directly from the manufacturer.

The following important symbols are used throughout this manual and on labeling affixed to the flowmeter:

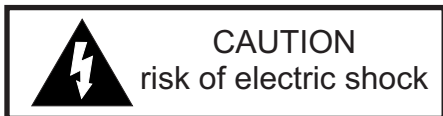

This symbol identifies a risk of electric shock where the possibility of injury or death is present.

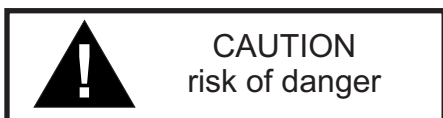

This symbol identifies a risk of injury or death is present.



In all cases, when this symbol is used on labeling affixed to the flowmeter, the documentation needs to be consulted to find out the nature of the potential HAZARD and any actions which have to be taken.

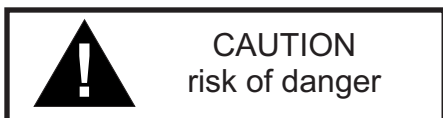

If the equipment is used in a manner not specified by this instruction manual, the protection provided by the equipment may be impaired.

QUESTIONS REGARDING THE SAFE USE OF THIS PRODUCT, THE LINUX OPERATING SYSTEM SOURCE CODE AND OTHER TECHNICAL ASSISTANCE MAY BE DIRECTED TO:

Blue-White Industries

Acceptable For Indoor and Outdoor Use

CAUTION - To reduce risk of electric shock, Disconnect electricity before removing back cover.

WARNING - Cord connected models must be connected to a properly grounded receptacle.

WARNING - Permanently connected models must be connected to a properly grounded terminal box.

See Intruction Manual.

ETL Listed
Conforms To UL STD 61010-1
Certified To
CAN/CSA STD C22.2 No. 61010-1
XXXXX

ENCLOSURE TYPE "NEMA" 4X
BOTTIER DE TYPE "NEMA" 4X

LABELING

1.0 Product Overview

1.1 Operating Principles

The **Sonic-Pro Hybrid Ultrasonic Flow Meter** can measure fluid flow in virtually any fluid in which sound waves can travel. The Sonic-Pro meter is considered “hybrid” because it can measure fluid flow using either the Doppler or Transit Time methods. The system includes a set of ultrasonic sound *Transducers* and a *Signal Processing Unit (SPU)*. The transducers are clamped to the outside of the pipe wall and include no moving parts. The SPU controls and processes the transducer signals into useful flow measurement data. This method of flow measurement is safe, non-intrusive and very easy to service.

1.2 Transit Time Operation

The Transit Time measuring method requires relatively “clean” fluid to enable the sound waves to complete their circuit. The meter may be operated in the Transit-Time mode when the fluid contains 0% to 10% (0 to 100,000 ppm) of particles. To allow for changes in the fluid’s particle count, the Sonic-Pro monitors the signal gain and employs an Automatic Gain Control (AGC) algorithm that automatically adjusts the gain to maintain the optimum power level.

The speed at which sound travels in the fluid must be known. The factory will configure the meter for a known fluid during the initial configuration. The Sonic-Pro model S3 includes a 5-button user interface that can be used to configure the meter. Many common fluids are listed in the software and can be selected directly from the menu. Provided the speed of sound in the fluid is known, custom “unknown” fluids can be input manually by the user. A list of various fluids and their sound speeds are provided in the index of this user manual.

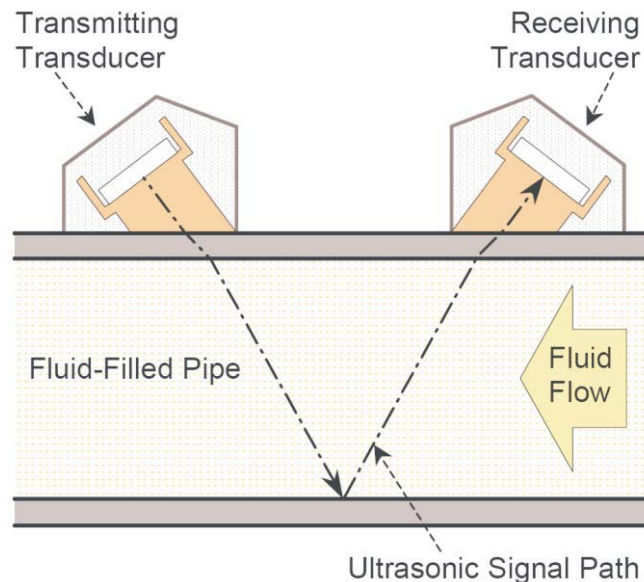

TRANSIT TIME MEASUREMENT PRINCIPLE

When operated in the Transit Time measurement method, a short ultrasonic signal burst passes first in one direction and then in the other between two transducers separated along the length of the pipe. When traveling in the same direction as fluid flow, the burst is carried along by the fluid and arrives earlier as a result. When traveling against fluid flow, the burst is held back by the fluid and arrives later. The SPU (Signal Processing Unit) measures this difference in time-of-flight in the two directions. From this, the actual time-of-flights, the distance traveled in the fluid and the angle of the ultrasonic signal path, it calculates the fluid velocity.

As well as the V mounting method shown, the transducers could be on opposite sides of the pipe with no reflections in the path (Z mount).

1.3 Doppler Operation

The Doppler measurement method requires that particles be present in the flow stream to “reflect” the sound waves. The particles must be of sufficient size, volume *and type* to reflect the sound waves. For example; although orange juice may contain pulp that is of sufficient size and volume, the properties of the pulp do not allow the sound waves to reflect. Therefore, the meter will not operate in the Doppler mode with orange juice containing pulp.

The meter may be operated in the Doppler mode when the fluid contains 0.02% to 15% (200 to 150,000 ppm) of particles that are at least 50 micron in size and have sufficient sound reflection properties.

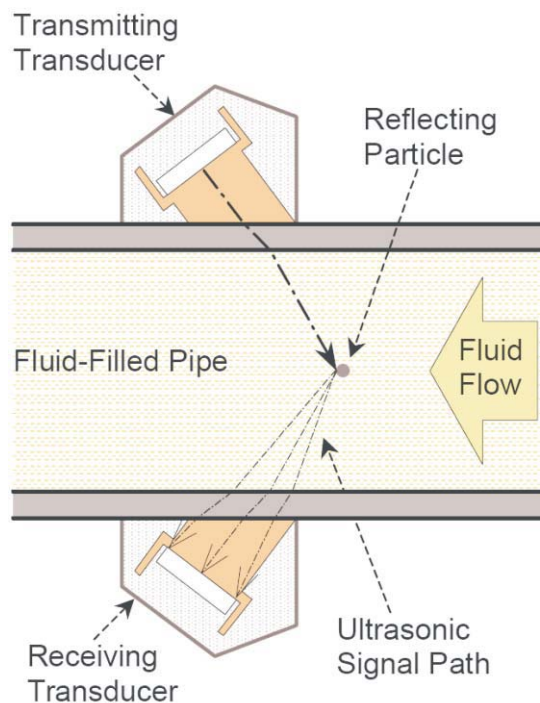

DOPPLER MEASUREMENT PRINCIPLE

When operated in the Doppler measurement method, a continuous-wave ultrasonic signal passes from a transmitting transducer into a pipe carrying a moving fluid. The signal is reflected by particles in the fluid and is picked up by a receiving transducer on the opposite side of the pipe.

When using the Doppler method, the transducers are installed directly opposite each other along the pipe axis, one each side of the pipe, either with or against the flow of fluid. The ultrasonic signal is subject to a Doppler shift when it is reflected from the particles moving at (nominally) the same velocity as the fluid. Therefore, the frequency at the receiving transducer will be slightly different from the transmitted frequency. The SPU (Signal Processing Unit) measures this difference in frequency and calculates the fluid velocity.

Note that the meter is actually measuring the velocity of the particles and *not the actual fluid*. For this reason, measurement error will occur if the particles do not move at the same velocity as the fluid, such as when the particles are heavier than the fluid or when the fluid is moving at such a low velocity that the particles drop out of suspension. Large “gulps” of air or particles will temporarily disrupt the flow measurement resulting in error.

1.4 Fluid Requirements

Doppler Operation	Transit Time Operation
<ul style="list-style-type: none"> • Must conduct sound • Must contain sound reflecting particles such as air bubbles, sand, etc. <p>Doppler measurement requires 0.02% to 15% (200 to 150,000 ppm) particles be present in the flow stream to “reflect” the sound waves.</p>	<ul style="list-style-type: none"> • Must conduct sound • Must be relatively clean fluid <p>Transit Time measurement requires relatively “clean” fluid. Fluids containing from 0% to 10% (0 to 100,000 ppm) of particles are acceptable.</p>

Note: Do not attempt to measure very low flow velocities in the Doppler mode, the particles can fall out of suspension resulting in error or failure.

1.5 Pipe Requirements

Pipe Material	Pipe Size Ranges and Maximum Wall Thickness		
	Doppler Mode Pipe Size Range	Transit Time Mode Pipe Size Range	Max Pipe Wall
Brass (Naval)	2" to 100" (63mm to 2500mm)	2" to 100" (63mm to 2500mm)	.500" (13mm)
Copper	2" to 100" (63mm to 2500mm)	2" to 100" (63mm to 2500mm)	.500" (13mm)
FRP (fiberglass Reinforced Plastic)	2" to 100" (63mm to 2500mm)	2" to 100" (63mm to 2500mm)	.500" (13mm)
Iron (cast)	2" to 100" (63mm to 2500mm)	2" to 100" (63mm to 2500mm)	.500" (13mm)
Iron (ductile)	2" to 100" (63mm to 2500mm)	2" to 100" (63mm to 2500mm)	.500" (13mm)
Nylon	1" to 100" (25mm to 2500mm)	1-1/2" to 100" (40mm to 2500mm)	2.00" (50mm)
Polyethylene (HDPE)	1" to 100" (25mm to 2500mm)	1-1/2" to 100" (40mm to 2500mm)	2.00" (50mm)
Polyethylene (LDPE)	1" to 100" (25mm to 2500mm)	1-1/2" to 100" (40mm to 2500mm)	1.00" (25mm)
Polypropylene	1" to 100" (25mm to 2500mm)	1-1/2" to 100" (40mm to 2500mm)	.500" (13mm)
PVC / CPVC	1" to 100" (25mm to 2500mm)	1-1/2" to 100" (40mm to 2500mm)	2.00" (50mm)
304 Stainless Steel	2" to 100" (63mm to 2500mm)	2" to 100" (63mm to 2500mm)	.500" (13mm)
304L Stainless Steel	2" to 100" (63mm to 2500mm)	2" to 100" (63mm to 2500mm)	.500" (13mm)
316 Stainless Steel	2" to 100" (63mm to 2500mm)	2" to 100" (63mm to 2500mm)	.500" (13mm)
Steel (1% carbon hard)	2" to 100" (63mm to 2500mm)	2" to 100" (63mm to 2500mm)	.500" (13mm)
Steel (carbon)	2" to 100" (63mm to 2500mm)	2" to 100" (63mm to 2500mm)	.500" (13mm)
Titanium	2" to 100" (63mm to 2500mm)	2" to 100" (63mm to 2500mm)	.500" (13mm)

Note: The outside surface of the pipe must be clean and smooth. Insulation, coatings, rust and other surface imperfections should be removed before installing the transducers. The inside surface of the pipe must be smooth to properly reflect the sound wave.

1.6 Straight Pipe Length Requirements

Type of Disturbance	Straight Lengths of Pipe Required	
	Upstream from Transducers	Downstream from Transducers
Flange	5 x Nominal Pipe Size	5 x Nominal Pipe Size
Reducer	7 x Nominal Pipe Size	5 x Nominal Pipe Size
90° Elbow	10 x Nominal Pipe Size	5 x Nominal Pipe Size
Two 90° Elbows - 1 Direction	15 x Nominal Pipe Size	5 x Nominal Pipe Size
Two 90° Elbows - 2 Directions	20 x Nominal Pipe Size	5 x Nominal Pipe Size
Gate valve	25 x Nominal Pipe Size	5 x Nominal Pipe Size
Pump	25 x Nominal Pipe Size	5 x Nominal Pipe Size

Note: The Sonic-Pro's sound wave beam is only affected by fluid that actually passes through the beam and therefore, the meter will not measure with high accuracy if the fluid velocity is not consistent across the entire pipe diameter. Flow disturbances such as pumps, elbows, tees, and valves in the flow stream can cause swirl patterns and vortices that will affect the measurement. Install the transducers on a straight run of pipe **as far as possible** from any disturbances. The distance required for high accuracy will depend on the type of disturbance.

1.7 Standard Model Features and Options

STANDARD MODEL FEATURES

- Data logging to a standard SD Card.
- 4-20 mA output signal
- 0-1000 Hz digital frequency output signal
- LED status indicator lights

DISPLAY AND USER ACCESS MODEL DISTINCTIONS

Sonic-Pro Model S3 includes a full featured display with a 5 button touch pad. The start-up process and the zero calibration can be performed by pressing the proper buttons on the touch pad.

Note that the start-up process, the zero calibration, and all other functions can also be performed by the optional remote PC software application.



Sonic-Pro Model S2 includes a basic display with a 2 button touch pad. The start-up process and the zero calibration can be performed by removing the front cover plate and pressing the setup button located on the circuit board.

Note that the start-up process, the zero calibration, and all other functions can also be performed by the optional remote PC software application.



Sonic-Pro Model S1 has no display or touch pad. The start-up process and the zero calibration can be performed by removing the front cover plate and pressing the setup button located on the circuit board.

Note that the start-up process, the zero calibration, and all other functions can also be performed by the optional remote PC software application.



OPTIONAL COMMUNICATIONS PACKAGE WITH CUSTOM PC SOFTWARE

Any Sonic-Pro model can be equipped with a **Communications Package** that includes circuitry, connector panel and custom PC software. When connected to a computer running the Sonic-Pro software, any model can perform the **Model S3** functions described in this manual including program editing and data logging downloads directly into the PC.

OPTIONAL PROCESS CONTROL RELAY BOARD

Any Sonic-Pro model can be equipped with a **Process Control Relay Package** that includes three independently programmable 10 amp relays. However, relay programming requires the Model S3 programming features or the Communications Software package to function. Models S1 and S2 cannot access the relay functions unless connected to the communications Software.

Sonic-Pro

**1.8
Wiring
Compartment**

WIRING COMPARTMENT

The wiring access door **on the front of the flowmeter enclosure only** must be removed to access the wiring terminal blocks, motherboard controls (a setup button and the measurement mode switch) and to view the status LEDs.

The meter is factory set for transit time operation.

There are no user serviceable items inside the rear enclosure.

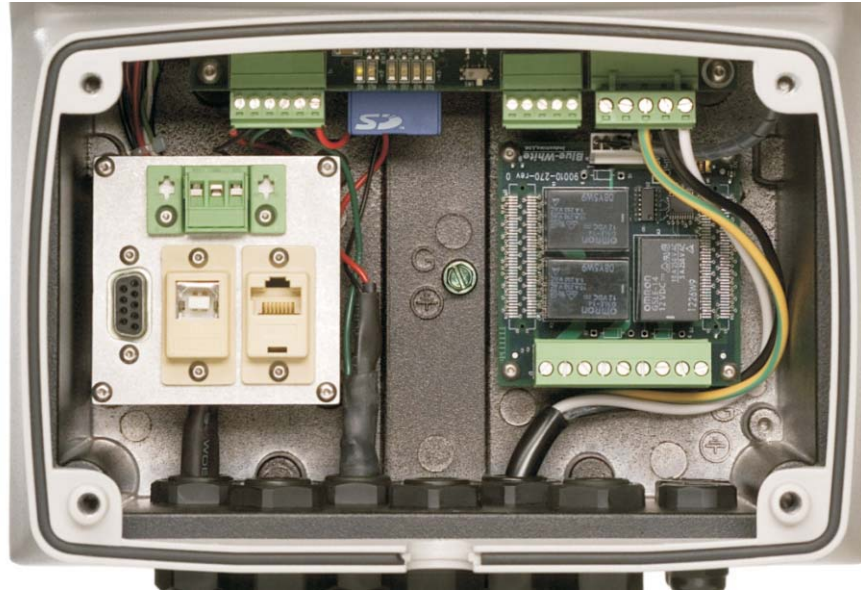

FRONT COVER PLATE REMOVED

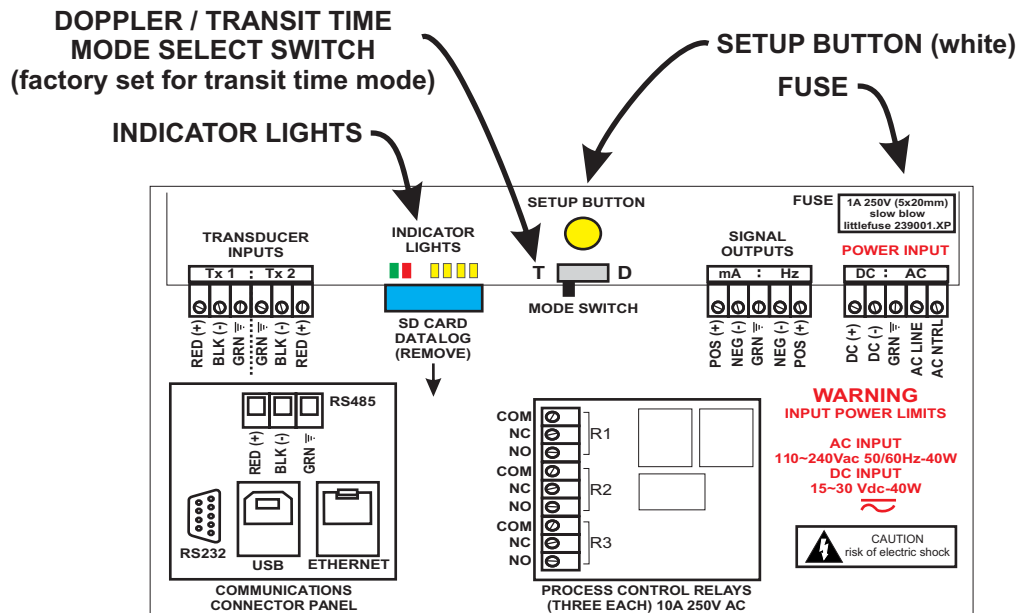

WIRING COMPARTMENT LAYOUT

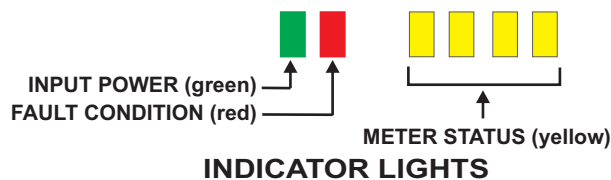

2.0 Quick Start Guide

1

Select doppler or transit time mode

Note that the meter is factory set for Transit-Time operation.

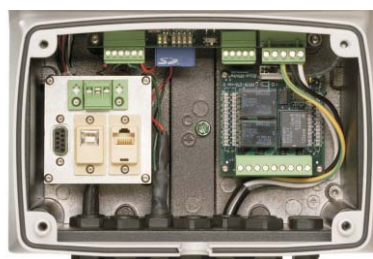

FRONT COVER PLATE REMOVED

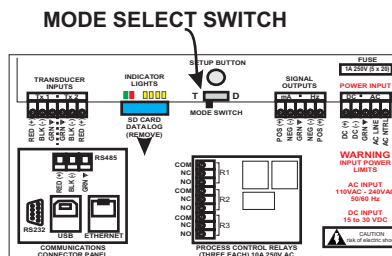

WIRING COMPARTMENT LAYOUT

See section 3.6 for more information

2

Select the transducer mounting location

The flowmeter's sound wave beam only measures fluid that actually passes through the beam, therefore, the fluid velocity must be consistent across the entire pipe diameter to ensure high accuracy. Flow disturbances such as pumps, elbows, tees, and valves in the flow stream can cause swirl patterns and vortices that will affect the measurement. Install the transducers on a straight run of pipe **as far as possible** from any disturbances. The distance required for accuracy will depend on the type of disturbance.

Type of Disturbance	Straight Lengths of Pipe Required	
	Upstream from Transducers	Downstream from Transducers
Flange	5 x Nominal Pipe Size	5 x Nominal Pipe Size
Reducer	7 x Nominal Pipe Size	5 x Nominal Pipe Size
90° Elbow	10 x Nominal Pipe Size	5 x Nominal Pipe Size
Two 90° Elbows - 1 Direction	15 x Nominal Pipe Size	5 x Nominal Pipe Size
Two 90° Elbows - 2 Directions	20 x Nominal Pipe Size	5 x Nominal Pipe Size
Gate valve	25 x Nominal Pipe Size	5 x Nominal Pipe Size
Pump	25 x Nominal Pipe Size	5 x Nominal Pipe Size

MINIMUM STRAIGHT PIPE LENGTHS

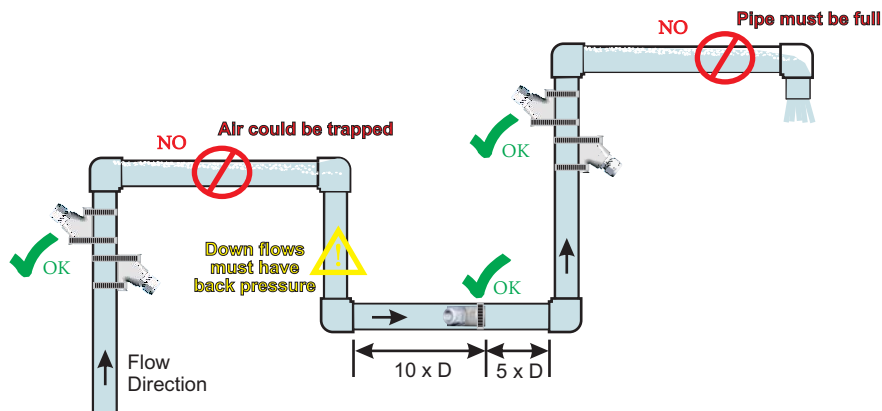

PIPE SYSTEM CONSIDERATIONS

See section 6.1 for more information

3

Determine the transducer mounting mode

When operated in the **Doppler** mode, the transducers are always mounted directly opposite each other, 180 degrees around the pipe.

When operated in the **Transit-Time** mode, the front faces of the transducers must face each other and be positioned the correct distance apart. In V-mode, the transducers are on the same side of the pipe. In Z-mode, the transducers are on the opposite side of the pipe, 180 degrees apart.

When factory configured, the appropriate **Transit-Time** mounting mode is pre-configured and printed on the serial label.

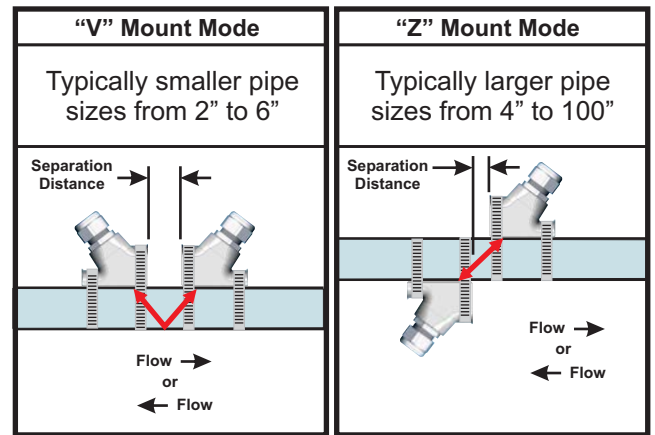
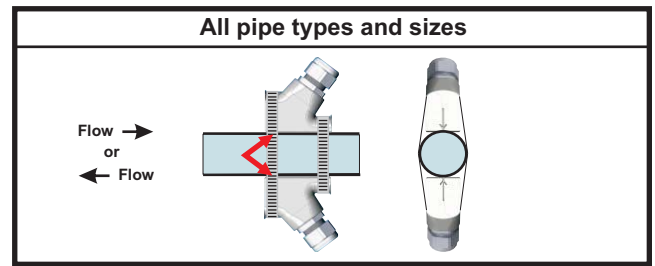

See section 6.2 for more information

4

Determine the 1st transducer location

The mounting surface must be clean, smooth and free of surface imperfections. Remove all insulation material, loose paint, etc. Clean the pipe thoroughly. Use sandpaper if necessary to remove surface imperfections. Be sure to locate the transducers on the side of horizontal runs of pipe. Do not mount the transducers over weld seams. Place a mark where the first transducer will be located.

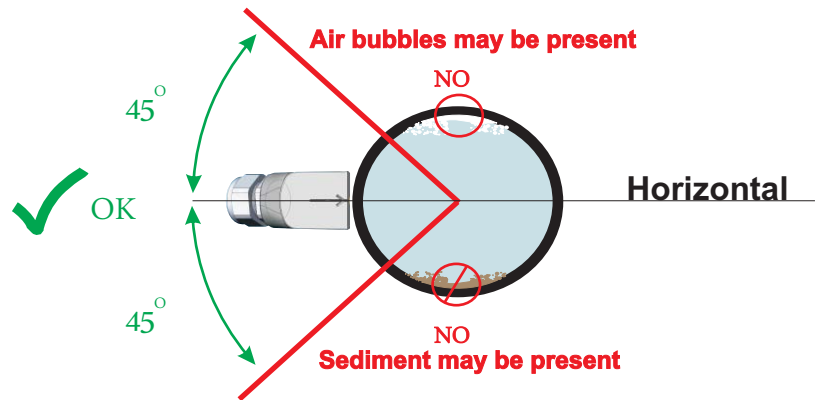

TRANSDUCER MOUNTING LOCATION

See section 6.5 for more information

5

Determine the 2nd transducer location

When operated in the **Doppler** mode, the transducers are always mounted directly opposite each other, 180 degrees around the pipe.

When operated in the **Transit-Time** mode, the factory configured separation distance and mounting mode is printed on the serial label. The currently active separation distance is also displayed on the run mode screen, the fault indicator screen, and when activating a new configuration.

If the meter has not been factory configured, or if a new configuration is required, the pipe outside diameter, pipe wall thickness, pipe material, fluid type and transducer mounting mode data must be input before proceeding.

Once activated, the new separation distance will be displayed.

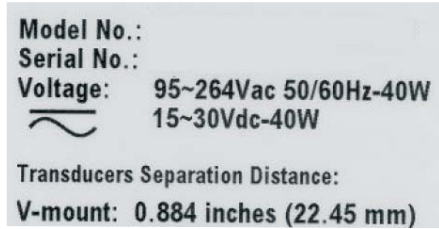
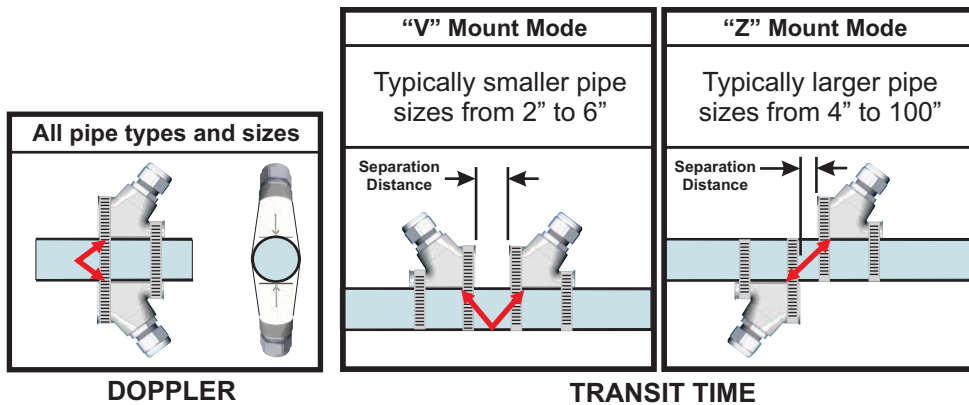

SERIAL LABEL

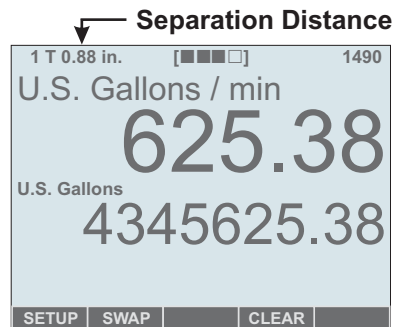

RUN MODE SCREEN

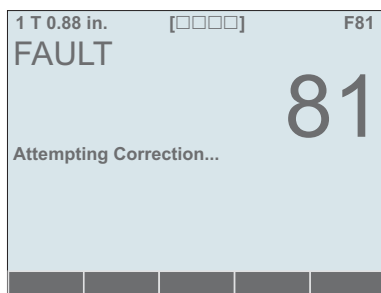

FAULT INDICATOR SCREEN

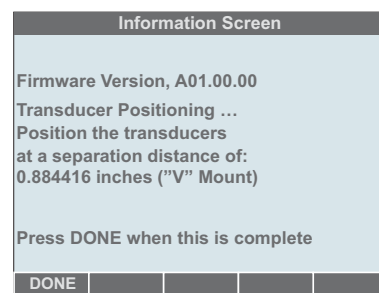

NEW CONFIGURATION ACTIVATION SCREEN

See section 6.6 for more information

6

Configure the meter if it has not been factory configured

Apply power to the meter. note that only the most basic configuration requirements are shown here.

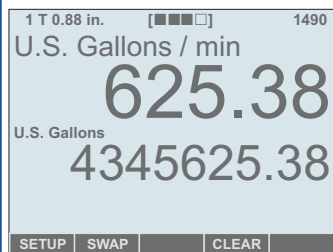

1. Press **Setup**.

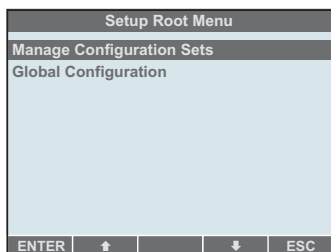

2. Highlight **Manage Configuration Sets** and press enter.

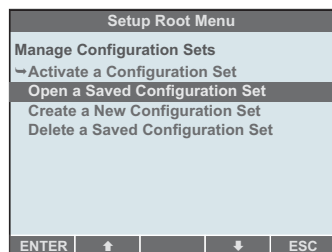

3. Highlight **Open a saved Configuration set** and press enter.

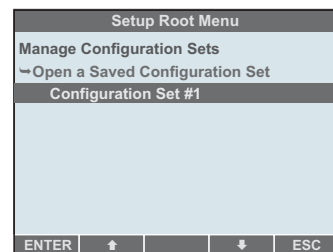

4. Highlight the **Configuration set** to be edited and press enter.

See section 5.0 for more information

6

Configure the meter (continued)

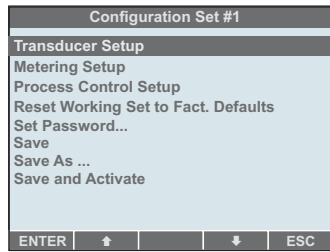

5. Highlight **Transducer Setup** and press enter.

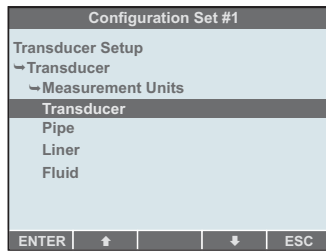

6. Highlight **Transducer** and press enter.

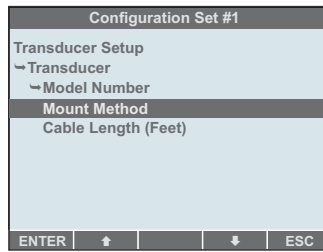

7. Highlight **Mount Method** and press enter.

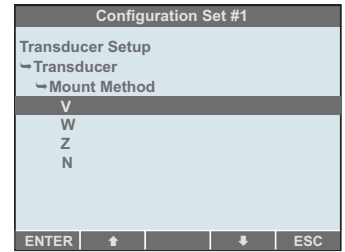

8. Highlight a **Mount Method** and press enter.

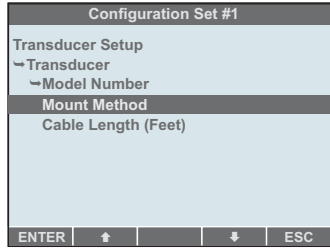

9. Press escape.

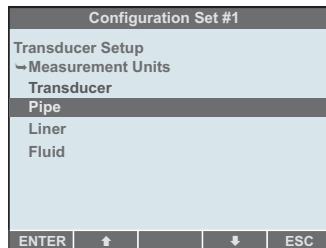

10. Highlight **Pipe** and press enter.

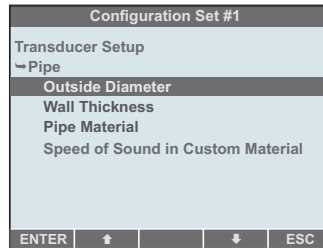

11. Highlight **Outside Diameter** and press enter.

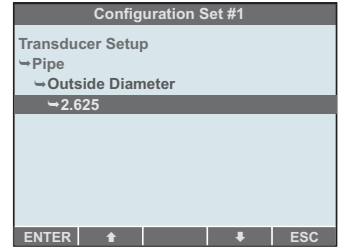

12. Input the actual outside diameter and press enter.

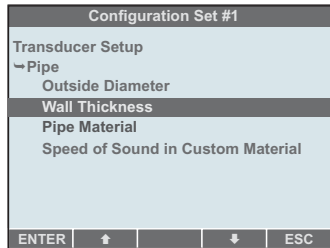

13. Highlight **Wall Thickness** and press enter.

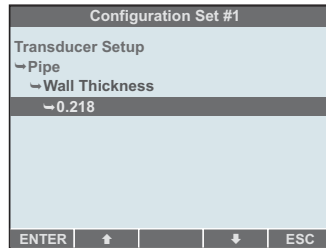

14. Input the actual wall thickness and press enter.

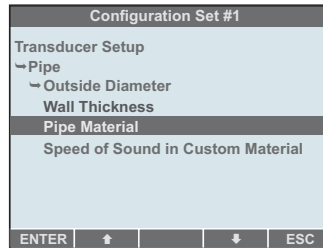

15. Highlight **Pipe Material** and press enter.

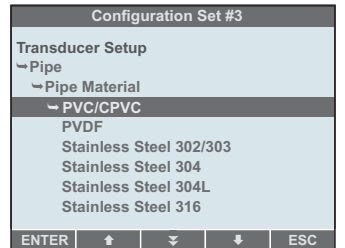

16. Highlight the actual **Pipe Material** and press enter.

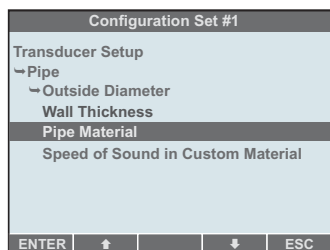

17. Press escape.

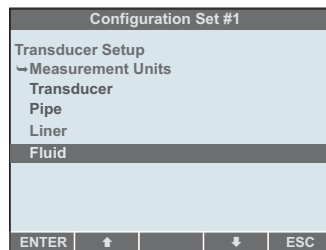

18. Highlight **Fluid** and press enter.

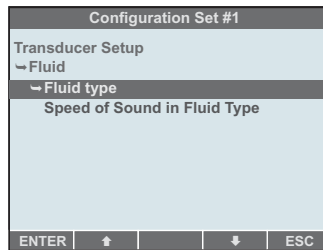

19. Highlight **Fluid Type** and press enter.

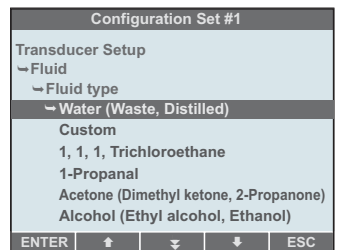

20. Highlight the actual **Fluid Type** and press enter.

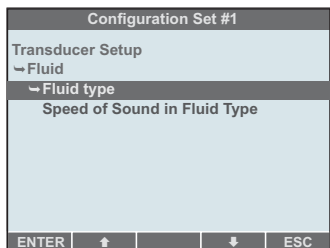

21. Press escape twice.

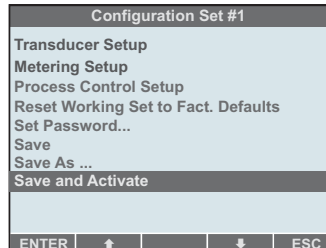

22. Highlight **Save and Activate** and press enter.

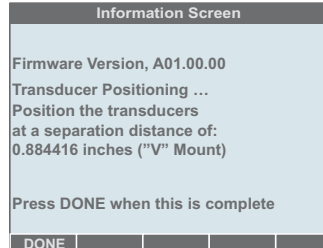

23. Position the Transducers on the pipe and press Done.

Setup Root Menu

Manage Configuration Sets

- ↳ Create a New Configuration Set
- ↳ Delete a Saved Configuration Set
- ↳ Activate a Configuration Set
- ↳ Open a Saved Configuration Set
 - ↳ Configuration Set #1
 - ↳ Configuration Set #2
 - ↳ Configuration Set #3
 - ↳ Configuration Set #4
 - ↳ Configuration Set #5

↳ Transducer Setup

- ↳ Measurement Units
 - ↳ English (U.S. units)
 - ↳ Metric (SI units)
- ↳ Transducer
 - ↳ Model Number
 - ↳ Mount Method
 - ↳ Cable Length (Feet)
- ↳ Pipe
 - ↳ Outside Diameter
 - ↳ Wall Thickness
 - ↳ Pipe Material
 - ↳ Speed of Sound in Custom material
- ↳ Liner
 - ↳ Liner Wall Thickness
 - ↳ Speed of Sound in Liner material
- ↳ Fluid
 - ↳ Fluid Type
 - ↳ Speed of Sound in Custom Fluid

↳ Metering Setup

- ↳ Flow Rate
 - ↳ Volume Units
 - ↳ Custom Unit Volume per U.S. Gallon
 - ↳ Time Units
 - ↳ Digits After Decimal Point
- ↳ Totalizer
 - ↳ Volume Units
 - ↳ Custom Unit Volume per U.S. Gallon
 - ↳ Digits After Decimal Point
 - ↳ Total Display Function
- ↳ Display
 - ↳ Display Language
 - ↳ Flow Rate Averaging
 - ↳ Display Update
 - ↳ Low Flow Cutoff
 - ↳ High Flow Cutoff
 - ↳ Scaling Offset
- ↳ Signal Output
 - ↳ Analog Output
 - ↳ Pulse Output
- ↳ Data Logging
 - ↳ Log Interval
 - ↳ Log Rate Setpoint
 - ↳ Log Totalizer Setpoint

Global Configuration

- ↳ Communications Settings
- ↳ Master Password
- ↳ Date and Time
- ↳ Save Changes

↳ Process Control Setup

↳ Relay Channel #1

- ↳ Assign Relay
 - ↳ Monitor Flow Rate
 - ↳ Monitor Flow Total
 - ↳ Disabled
- ↳ Flow Rate Alarm Settings
 - ↳ High Trigger
 - ↳ High Release
 - ↳ Low Trigger
 - ↳ Low Release
 - ↳ Alarm Delay Time
- ↳ Batch Dispense Settings
 - ↳ Default Batch Amount
 - ↳ Batch Start Mode
 - ↳ Manual Batch Start
 - ↳ Auto (Proportional)
 - ↳ Relay Timer

↳ Relay Channel #2

- ↳ Assign Relay
 - ↳ Monitor Flow Rate
 - ↳ Monitor Flow Total
 - ↳ Disabled
- ↳ Flow Rate Alarm Settings
 - ↳ High Trigger
 - ↳ High Release
 - ↳ Low Trigger
 - ↳ Low Release
 - ↳ Alarm Delay Time
- ↳ Batch Dispense Settings
 - ↳ Default Batch Amount
 - ↳ Batch Start Mode
 - ↳ Manual Batch Start
 - ↳ Auto (Proportional)
 - ↳ Relay Timer

↳ Relay Channel #3

- ↳ Assign Relay
 - ↳ Monitor Flow Rate
 - ↳ Monitor Flow Total
 - ↳ Disabled
- ↳ Flow Rate Alarm Settings
 - ↳ High Trigger
 - ↳ High Release
 - ↳ Low Trigger
 - ↳ Low Release
 - ↳ Alarm Delay Time
- ↳ Batch Dispense Settings
 - ↳ Default Batch Amount
 - ↳ Batch Start Mode
 - ↳ Manual Batch Start
 - ↳ Auto (Proportional)
 - ↳ Relay Timer

7

Install the transducers

An acoustic coupling material must be placed between the transducer and the pipe surface at the point where the sound waves enter the pipe.

Draw a centerline on the pipe parallel to the pipe center. Place the first transducer onto the pipe. Locate the front arrow exactly over the first separation distance mark (A). Place the transducer straight and parallel to the centerline.

Secure the first transducer to the pipe using the pipe clamps. The arrows on the front and rear of the transducers must point toward the centerline.

Locate the second transducer separation mark (B). Place the second transducer so that the front arrow is located exactly over the mark (B). Place the transducer straight and parallel to the centerline. Be sure that both transducers are facing each other and parallel to the pipe centerline.

Check that the separation distance is correct. Tighten the clamps equally.

See section 6.9 for more information

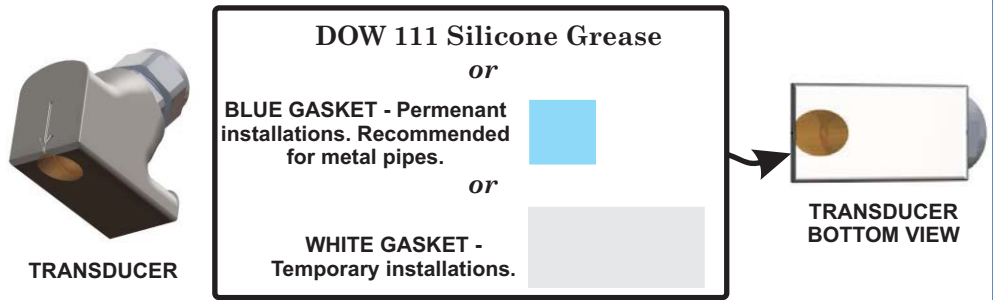

ACOUSTIC COUPLING MATERIAL INSTALLATION

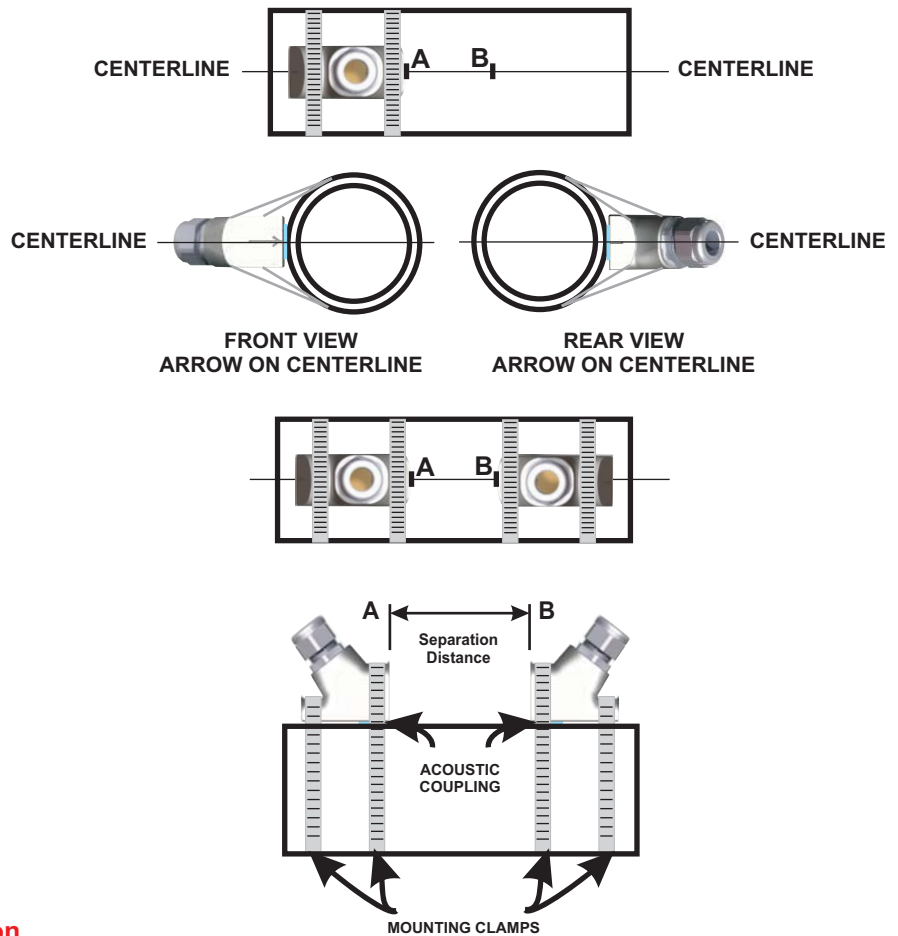

8

Restart the meter

Press the SETUP button. The meter will enter the **SETUP ROOT MENU**. Creation and modification of the five available Configuration Sets and the Global Configuration settings can be made from this menu. If no changes are to be made, press **ESC**. The meter will re-start.

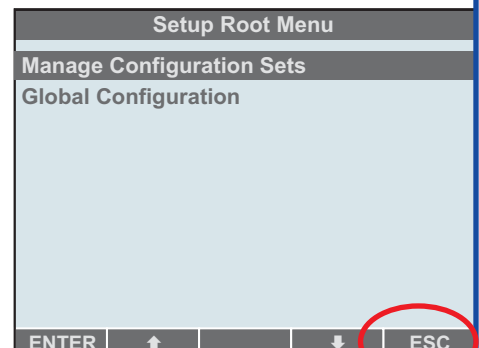

3.0 Flowmeter SPU Installation

3.1 Unpacking

The Sonic-Pro Flowmeter is shipped in a carrying case. Inside the carrying case you will find the following items:

- Sonic-Pro Flowmeter SPU (Signal Processing Unit)
- Sonic-Pro Transducer Set
- Enclosure Mounting Hardware
 - 2 mounting plates
 - 4 mounting plate screws (10-32 x .50")
 - 4 panel mount screws (8-32 x 3.00")
 - 2 wall mounting screws (#10 x 1.00")
 - 1 panel mounting gasket
 - 1 pipe mounting clamp (maximum pipe diameter 10")
- Transducer Mounting Kit
 - 6 blue gaskets (single use)
 - 2 white gaskets (multi use)
 - 4 transducer mounting clamps (maximum pipe diameter 10")
- Paper Instruction Manual (English)
- CD Instruction Manual (English, Spanish, German, French)

Note that additional clamps can be purchased and connected for larger pipe diameters.

3.2 Select a Mounting Location

The Sonic-Pro was designed to be installed and operated by qualified personnel only. Do not attempt to install or operate the meter if you are unsure. Seek qualified assistance. **Please note that warranty coverage does not include damage due to misuse or improper installation.**

Select a mounting location for the SPU that is within reach of the transducer cables and power supply. The standard transducer cable length is 10 feet and must not be cut or modified. Note that the Sonic-Pro can accurately measure flow from either direction.

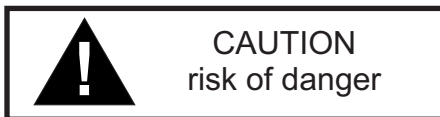

Do not position the equipment so that it is difficult to disconnect the power supply cord.

The SPU can be mounted on a wall, on a horizontal or vertical run of pipe or in panel. Although the Sonic-Pro is designed to withstand outdoor conditions. A cool, dry location, where the unit can be easily monitored is recommended. Special ventilation is not required.

3.3 Wall Mounting

- 1) **The SPU must be installed on a solid, secure surface** such as a solid wall, panel, wall studs, etc. **DO NOT** install the meter on drywall with anchor bolts.
- 2) Measure and mark the distance between the keyhole slot centers as shown.
- 3) Drill two 5/32" diameter pilot holes. Install the enclosed #10 x 1.00" screws into the wall. Leave the screw heads away from the panel surface approximately 1/4".
- 4) Hang the SPU enclosure on the screws.

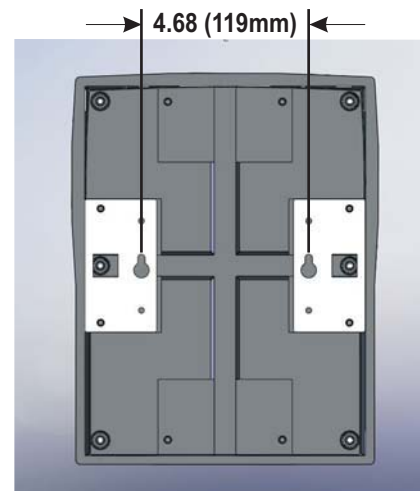

Sonic-Pro**3.4
Panel
Mounting**

- 1) The SPU can be panel mounted. Measure and cut an opening in the panel as shown.
- 2) Remove the two mounting plates from the rear of the enclosure.
- 3) Install the gasket onto the rear of the front panel of the SPU enclosure.
- 4) Place the enclosure into the panel.
- 5) Re-install the two mounting plates as shown.
- 6) Thread the four 8-32 x 3.00" machine screws through each of the two outer tapped holes in the mounting plates. Tighten the screws to secure the enclosure to the panel.

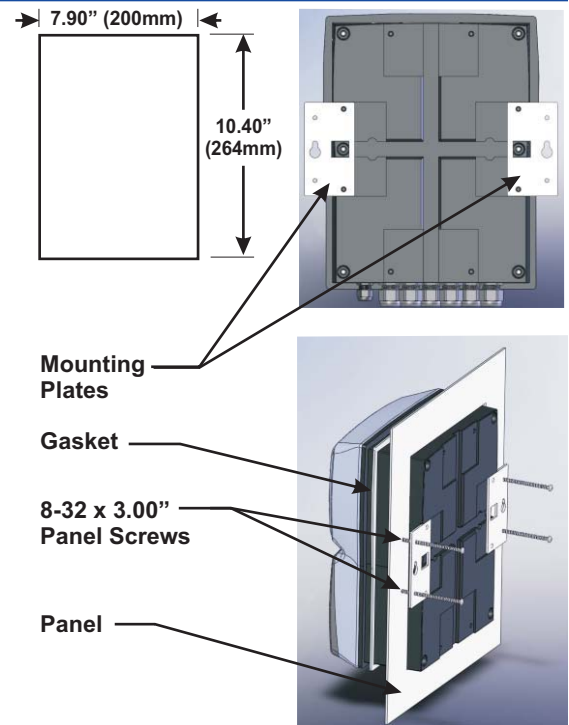
**3.5
Pipe
Mounting**

- 1) The SPU can be mounted on horizontal or vertical pipe. The pipe must be secure and of sufficient strength to support the weight of the SPU.
- 2) Install the two mounting plates onto the rear of the enclosure. For horizontal pipe mounting, install the mounting plates on the top and bottom plate cut-outs. For vertical pipe mounting, install the mounting plates on the side plate cut-outs.
- 3) Thread the long mounting clamp through the square cut-outs in the mounting plates as shown.
- 4) Wrap the clamp around the pipe and tighten loosely. Be sure the pipe is seated in the pipe groove, then tighten securely.

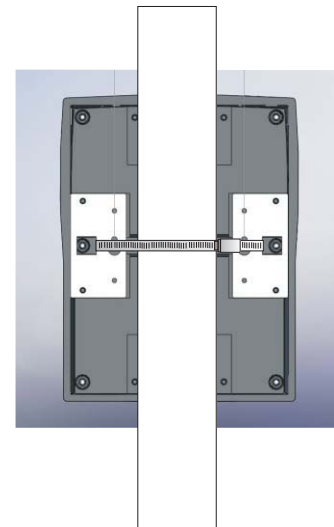
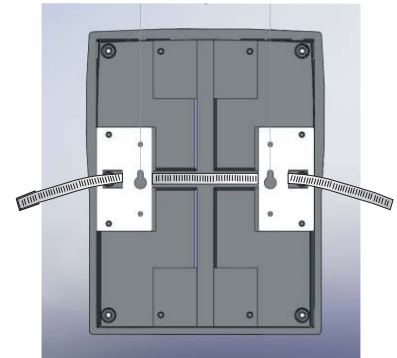

3.6 Select the Measurement Method

Open the front cover of the SPU. Position the Doppler/Transit-Time switch to the preferred operating mode (factory setting is transit time). Operate the meter in the Transit Time mode (best accuracy) if the fluid contains little or no particles (up to 10% maximum). Operate the meter in the Doppler mode if the fluid to be measured contains more than 10% particles.

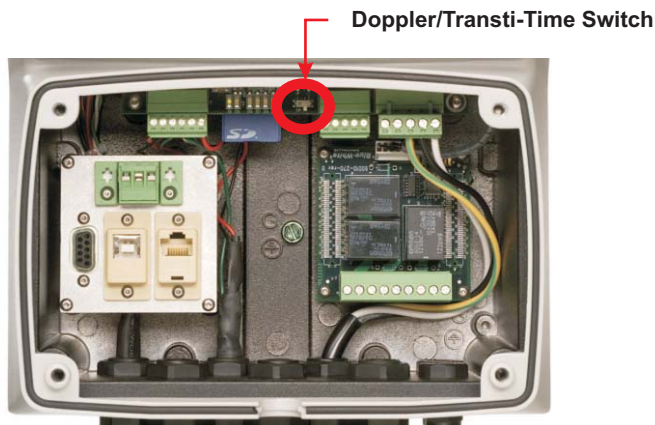

3.7 Electrical Connections

The Sonic-Pro transducer connections are pre-wired at the factory. If a main AC input power cord selection was made when ordering, the power cord and main AC power input connection is factory wired. When powering the meter by DC, a power cable for this purpose should be installed in one of the cable gland liquid-tight connectors. See section 3.8 below. The meter will automatically adjust for any main power input that is within the power requirements range of 110 to 240 volts AC or 15 to 30 volts DC. See the diagram below for wiring of output signals, communications signals and process control relays.

 **CAUTION**
risk of electric shock

All high voltage connections in the front wiring compartment are considered "finger safe". However, disconnect electricity to the meter and use care when connecting high voltage wires to the plug-in type terminal blocks.

 **CAUTION**
risk of electric shock

There are **no user serviceable items** inside the rear meter enclosure. If it becomes necessary to open the back cover, be sure to disconnect the main power supply before opening the back cover of the enclosure.

The transducer cable length is fixed. Do not attempt to modify the length of the cables. Various cable lengths are available from the factory. Contact the factory if you need assistance. Shielded cable is recommended for signal output connections.

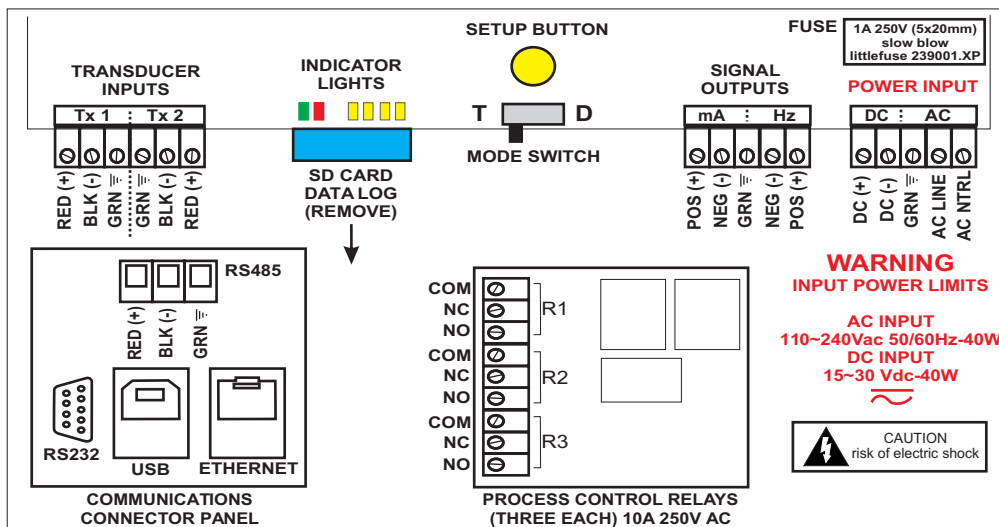

WIRING CONNECTIONS

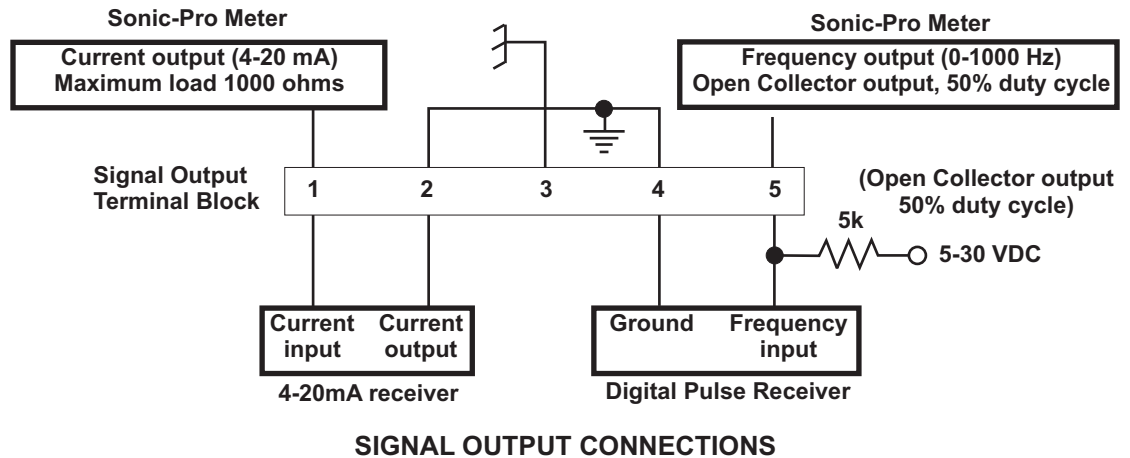
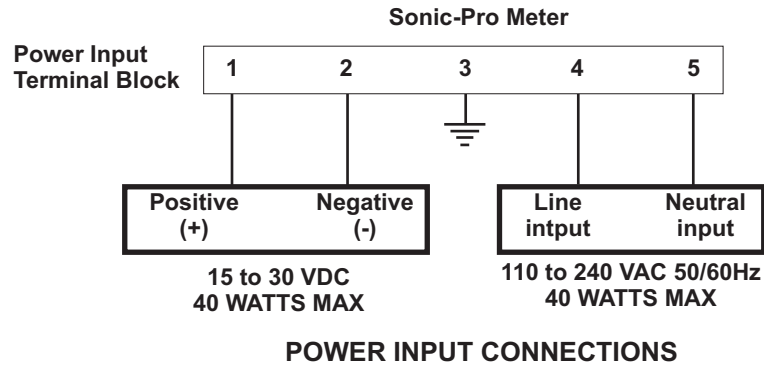

3.8 Cable Gland Liquid-Tight Connections

The Sonic-Pro SPU wiring compartment is equipped with:
six large liquid-tight cable gland connectors,
two small liquid-tight cable gland connectors, and
a communications cable liquid-tight cable gland grommet and plug.

To ensure that the SPU enclosure remains water-tight, the following cable glands should be used:

The **six large liquid-tight connectors** can be used with any cable diameter from .200 to .394 inches (5.1 to 10.0 mm). They are provided for:

- 1 each for the power input cable
- 2 each for the transducer cables
- 3 each for the process control relay connection cables

The **two small liquid-tight connectors** can be used with any cable diameter from .118 to .255 inches (3.0 to 6.5 mm). They are provided for:

- 1 each for the 4-20 mA output signal cable
- 1 each for the pulse output signal cable

The **communications cable grommet** can be used with any cable diameter from .190 to .205 inches. It is provided for any one of the following cable types:

- USB cable
- Ethernet Cable
- RS-232 serial cable
- RS-485 serial cable

The **blank grommet plug** should be used when the communications cable grommet is not required.

4.0 Overview of Flowmeter Operation

4.1 Power On and Self-Test

On application of power, the power LED (green) on the motherboard comes on and the flowmeter performs self-test functions. The approximate duration of self-test is 10 seconds. The flowmeter indicates that it is in the Self-Test State as follows:

Model S1: the red and all four yellow LED indicator lights flash at 1 Hz.

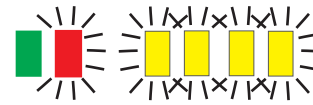

INDICATOR LIGHTS IN SELF-TEST STATE

Model S2: as for Model S1, plus the LCD shows the firmware version number and the text "Self-Test ...".

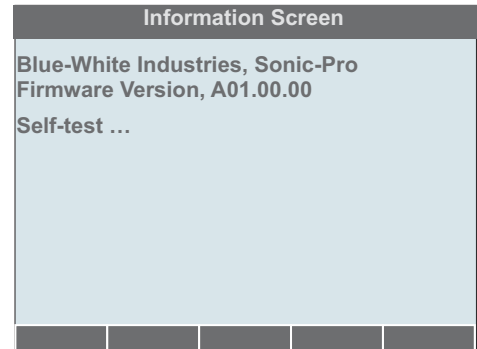

LCD DISPLAY

Model S3: as for Model S2.

4.2 Description of Operating States and Controls

Below is a diagram of the Sonic-Pro's major operating states. The condition of the motherboard LEDs is pictured under the name of each state. Transitions are annotated with their causes, which may be user actions via the motherboard controls and timeouts (uppercase text), user actions using a display optionally fitted to the flowmeter, (*italic text*) or automatic transitions when a step is complete (in parentheses).

In the Self-Test state, the flowmeter checks the operation of internal circuitry, such as communication between the processor and its peripheral functions, Verify that all LEDs and the LCD display, if fitted, are working properly. Do not press any buttons during self-test.

If an error condition is detected during self-test, the flowmeter enters the Faulted State. Failure of the LEDs, LCD display, and the display touch-pad are not internally detectable.

If self-test completes without error, the flowmeter enters the Startup State. *Note that completion of self-test does not guarantee that the flowmeter is properly configured and able to make accurate measurements.*

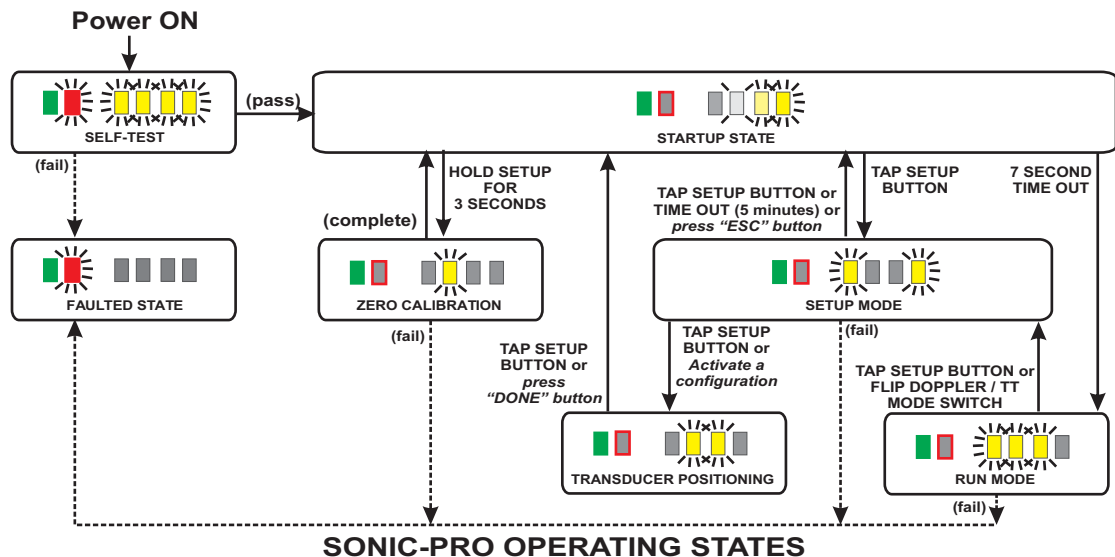

Sonic-Pro

**4.3
Startup
State**

When power is applied, the flowmeter enters the Startup state. In the Startup State, the flowmeter waits for up to 7 seconds for the Setup button to be pressed at which time the Setup mode is entered and changes to the configuration can be made. If the setup button is not pressed, the flowmeter will enter the Run Mode and attempt to start flow measurement. If the transducers are not installed on the pipe, a fault will occur. The location of the Setup button is as follows:

Model S1: a push-button switch on the controller motherboard.

Model S2: as for Model S1.

Model S3: as for Model S2, plus a SETUP soft button appears on the display.

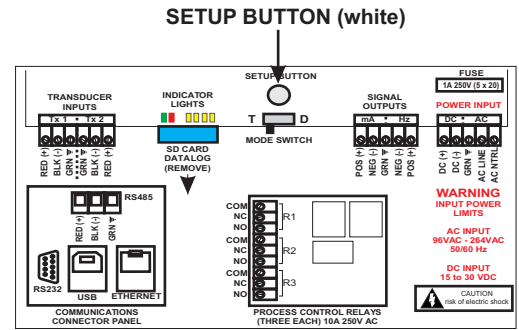

CIRCUIT BOARD LAYOUT

The flowmeter indicates that it is in the Startup State as follows:

Model S1: the Fault (red) LED is OFF and all yellow LEDs are at first ON and then turn OFF one by one, starting at LED1, at intervals of 1.5 seconds, so as to count down the 7 second pause.

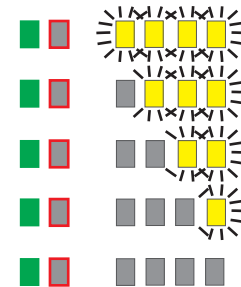

MODEL S1

Model S2: as for Model S1, plus the display screen indicates:

- Startup ...
- Tap Setup to enter Setup Mode
- Hold Setup for Zero Calibration
- Configuration set #
- (Searching for SD Card)

Below this, a “progress bar” counts off the 7 second delay.

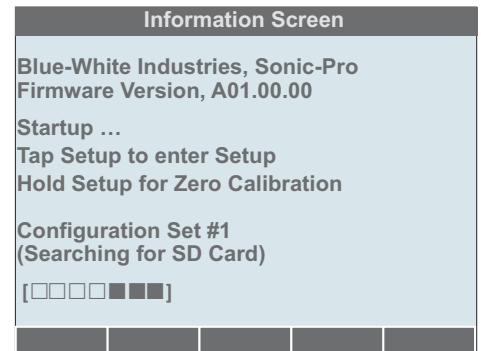

MODEL S2

Model S3: as for Model S2, plus the SETUP soft button is available.

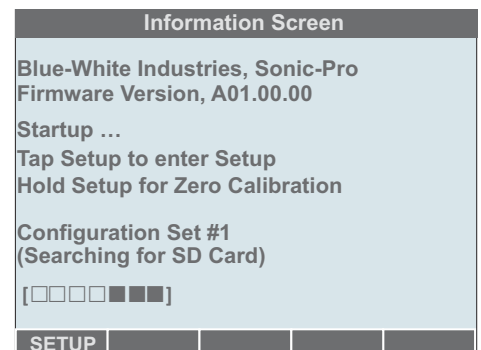

MODEL S3

4.4 Setup (Configuration) Mode

From the **Setup** mode, a zero calibration can be performed or, if equipped with either the full function display (Model S3) or the optional Communications software, the **Setup Root Menu** system can be entered and the meter can be configured. The operations that can be performed in the **Setup Root Menu** are fully described in section 5.0.

The **Setup Mode** can be entered in two ways:

- 1) Tap the **SETUP** button on the motherboard, the display touch-pad, or on the user PC Communications Software.
- 2) Flip the Doppler/Transit Time switch.

Note: the meter must be in the Startup State or in the Run Mode to enter the Setup Mode.

The flowmeter indicates that it is in the **Setup Mode** as follows:

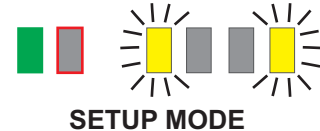

Model S1: two outer yellow LEDs flash at 1 Hz.

Model S2: as for Model S1, plus the display screen indicates:
Setup Mode...

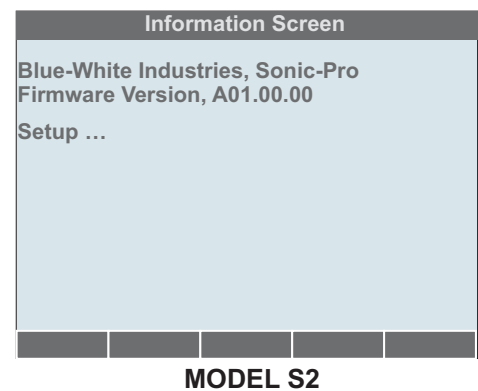

Model S3: as for Model S2, plus the **Setup Root Menu** appears.

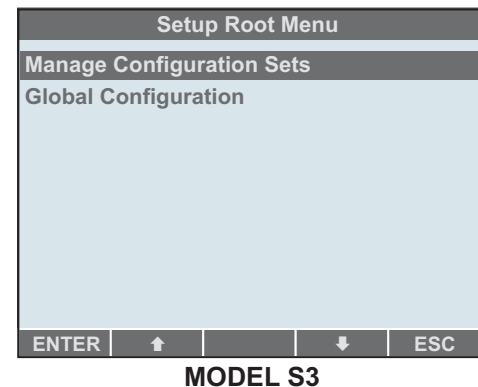

The flowmeter will remain in the **Setup Mode** until one of the following actions occur:

- 1) **A Configuration Set is activated from the Setup Root Menu.**
Either the full function display (Model S3) or the optional Communications software is required for this action.
- 2) **The user “escapes” from this state.**
The user can escape to the Startup state by:
 - a) **Hold** the **SETUP** button on the motherboard for three seconds.
 - b) **Tap** the **SETUP** button on the motherboard once (resulting in entering the Transducer Positioning state) and **tap** again (resulting in entering the Startup state).
 - c) Press the **ESC** button on the full function display (Model S3) or on the optional Communications software.

Note that if the user escapes, the currently active configuration set will re-activate.
- 3) **Five minutes passes without user action.**

Sonic-Pro

4.5 Transducer Positioning State

In the **Transducer Positioning State**, the flowmeter waits for the transducers to be correctly positioned on the pipe.

When operated in the Transit Time measurement mode, the separation distance of the transducers is computed by the flowmeter from the information in the **Transducer Setup** branch of the **Configuration Menu**. The correct separation distance is dependent on the pipe OD, pipe wall thickness, pipe type and chosen mounting mode. If the Doppler measurement mode is selected (by the motherboard switch), the separation of the transducers (along the pipe axis) is always zero.

When factory configured, the separation distance and mounting mode is printed on the serial label. The separation distance will also be displayed on the LCD display or on the optional communications PC software, in either inches or millimeters depending on the **Measurement Units** chosen in **Transducer Setup**. If the meter has not been factory configured, or if a new configuration is required, the pipe OD, pipe wall thickness, pipe type, fluid type and chosen mounting mode configuration data must be input before proceeding. See section 5.3 for instructions on how to create or modify a configuration.

If the flowmeter has neither an LCD display nor a connected user **PC Software** application, then the Configuration information cannot be changed by the user so the separation of the transducers will not change from the factory setting.

The flowmeter indicates that it is in the **Transducer Positioning State** as follows:

Model S1: two center yellow LEDs flash at 1 Hz.

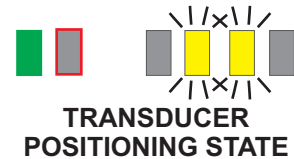

Model S2: as for Model S1, plus the screen presents instructions to the user as shown.

Model S3: as for Model S2.

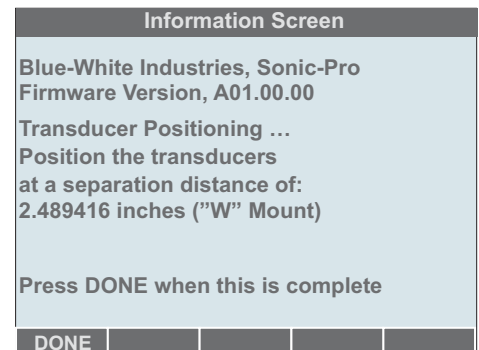

You must acknowledge that the transducers are correctly positioned by either pressing the **SETUP** button on the motherboard or the **DONE** soft button on the display, if fitted. The flowmeter will then return to the **Startup** state, see section 4.3 above, from which you can again enter **Setup Mode** or perform **Zero Calibration** or, by allowing the 7 second timeout to elapse, let the flowmeter enter **Run Mode** and begin flow measurement.

4.6 Zero Calibration State

If the Transit Time measurement mode is selected, a zero calibration should be performed if possible. There must be no movement of fluid in the pipe during the calibration. It is not necessary to perform zero calibration if Doppler measurement mode is selected, however it is harmless and will have no effect on the measurement.

In the Zero Calibration State, the flowmeter measures and records the apparent rate of fluid flow to offset measurements in Run Mode and compensate for any zero flow error. This information is associated and stored with the active Configuration Set and survives power loss and restarts. If a new Configuration Set is made activate, it will have its own zero calibration information. Therefore, the calibration must be performed after the configuration is created and saved. Although the zero calibration is not required, positive or negative zero offset reading error may result if the calibration is not performed.

The approximate duration of zero calibration is 15 to 20 seconds. There must be no movement of fluid in the pipe. Do not perform zero calibration if it is not possible to establish zero fluid flow in the pipe. If there is flow during zero calibration, then flow measurement in Run Mode will be inaccurate. The only means provided to cancel zero calibration or to undo its effect is to perform another zero calibration.

Zero calibration must be started while in the Startup State by holding down the SETUP button for at least 3 seconds. The Startup State may be entered by power cycling the flowmeter or upon exit from the Setup Mode or Transducer Positioning state. With either the Model S3 display or the optional Communications Board and a connected Host PC, the Setup Mode can be activated directly from the Run Mode by pressing the SETUP button and then the pressing the ESC button.

On completion of zero calibration, the flowmeter returns to the Startup State and will again wait for up to 7 seconds for the Setup button to be pressed.

The flowmeter indicates that it is in the Zero Calibration State as follows:

Model S1: one yellow LED flashes at 1 Hz

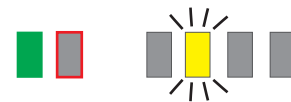

**INDICATOR LIGHTS DURING
ZERO FLOW CALIBRATION**

Model S2: as for Model S1, plus the display screen indicates:

Zero Calibration ...

Below this, a “progress bar” counts off the 15 to 20 second delay.

Model S3: as for Model S2.

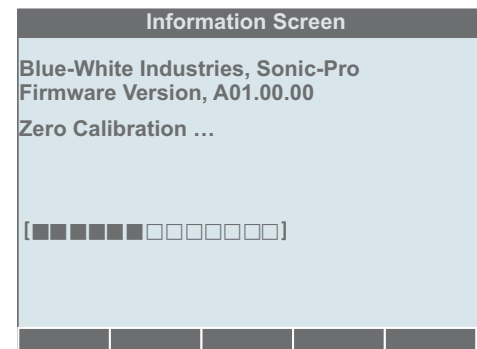

MODEL S2 and MODEL S3

Sonic-Pro**4.7
Run
Mode**

In the **Run Mode**, the flowmeter performs flow measurement, updates the 4 to 20 mA and pulse signal outputs, displays and logs data and performs process control actions according to the active configuration.

The flowmeter indicates that it is in the Run Mode as follows:

Model S1: Yellow LEDs indicate the present “Goodness of Measurement”.
one light = poor quality
four lights = best quality

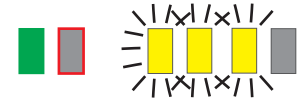

**INDICATOR LIGHTS DISPLAYING
GOODNESS OF MEASUREMENT**

Model S2: as for Model S1, plus the **Run Mode** screen appears, including an indication of “Goodness of Measurement” on the top line and the calculated speed of sound in the fluid if in Transit Time measurement mode.

Model S3: as for Model S2 (see section 1.7 for some minor differences between Model S2 and S3 displays).

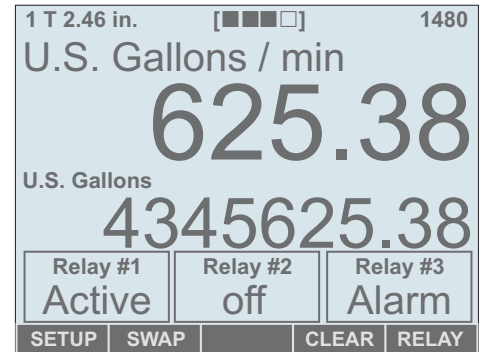

MODEL S2 and MODEL S3

The flowmeter remains in the **Run Mode** until it is powered down, the user takes an action to go to Setup Mode or, exceptionally, an error occurs and the flowmeter goes to the **Faulted State**. The user can command the flowmeter to **Setup Mode** by pressing the motherboard setup button or changing the position of the measurement mode switch between Transit Time and Doppler. If the **Model S3 Display** or the **Communications PC Software** is connected, the user can additionally press the **SETUP** soft button.

For a complete description of **Run Mode** operation, see section 7 below.

**4.8
Fault and
Warning
Error Codes**

The flowmeter enters the Faulted or Warning State if:

- 1) The flowmeter self-test fails.
- 2) A configuration error is detected on exit from **Setup Mode**.
- 3) An error condition occurs during flow measurement in **Run Mode** or **Zero Calibration**.

Faults and **Warnings** will be identified by two-digit error codes.

- A **Fault** will cause the meter to discontinue flow measurement. Note that the 4-20mA analog output signal and 0-1000 Hz pulse output signal sets to the minimum values (fail safe low), and all relays will respond as if in a zero flow condition.
- A **Warning** will not interrupt flow measurement, output signals, or relay functions.

The fault LED will flash at a rate of 2 pulses per second (ON for 250 ms and OFF for 250 ms) to count out the first digit of the error code, will then stay OFF for 1.25 second, will then flash again at a rate of 2 pulses per second to count out the second digit and then stay OFF for 5 seconds. The code will repeat. The digit 0 will not be used, so that 81 codes are available. The errors that can occur and their assigned codes are listed below.

Example: 8 flashes >>> 1.25 second pause >>> 1 flash >>> 5 second pause = Fault 81

4.8 Fault and Warning Error Codes (cont.)

The flowmeter indicates that it is in the **Faulted State** as follows:

Model S1: The Fault LED (red) flashes to identify the error (note that this LED is on the motherboard and the wiring access door must be opened to see it) . All yellow LEDs are off.

Model S2: as for Model S1, plus the error code appears in the upper right hand corner of the **Run Mode** display screen.

Model S3: as for Model S2.

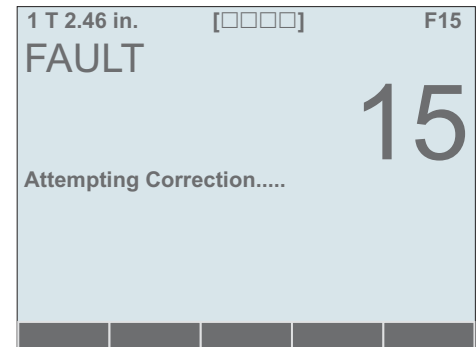
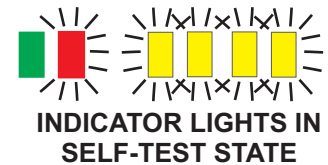

MODEL S2 and MODEL S3

The **Faulted state** will attempt to self correct, however, if the error is due to a configuration problem such as impossible pipe geometries, the configuration error must be corrected before the fault condition will clear. Repositioning the transducers may be required before the fault can correct itself. A fault that is caused by an empty pipe condition, excessive air or particles in the fluid, or other such flow stream disturbances will self correct when the flow stream returns to an acceptable condition.

The Fault and Warning codes and their respective numbers are listed below. See the troubleshooting guide in the index of this manual for more information about correcting for errors.

Fault Codes

- F15** Transit Time: Burst onset not detected
- F13** Transit Time: Measured sound speed exceeded the configured allowable limit
- F19** Improbable flow rate over 40 feet per second (12 meters per second)
- F81** Receive signal too weak or absent during burst accusation
- F91** Impossible pipe geometries

Warning Codes

- W11** Receive signal near lower limit of operation
- W12** Receive signal too strong
- W13** Transit Time: Measured sound speed exceeded the configured allowable limit
- W16** Transit Time: Burst onset not detected
- W17** Transit Time: Periodic burst onset detection has large decrease in confidence
- W18** Transit Time: Large gain in periodic receiver gain adjustment detected
- W37** Improbable scaling offset (e.g. less than 0.5 or greater than 2.0)

The user can configure a fluid sound speed limit value. This feature can be used to monitor the fluid and alert the user to changes in fluid density. Should the measured sound speed be greater then the acceptable percentage of error, error code 13 will be recorded. Error code 13 can be configured to result in either a fault condition or a warning condition. The default setting is recorded as a fault. See section 5.4.3 for more information on this feature.

5.0 Setup (Configuration) Mode

The Setup (configuration) Mode screens are available on the Model S3 only. However, if the communications option is included, any of the models S1, S2 or S3 can access the setup mode by using the PC Software Application.

5.1 Menu Navigation

The function of the soft buttons for menu navigation is as follows:

ENTER Perform an appropriate action on the highlighted item:

- Select the item.
- If an editable value, edit the value.
- If the item has options, show the options.
- If the item is a selectable option, choose it and move one place back up the menu tree.

↑ Move the highlight up in the list of menu items or options.

↓ Move the highlight down in the list of menu items or options.

ESC Move one place back up the menu tree, abandoning any change at the current position. If this soft button is pressed at the top level of a menu, leave the menu entirely, abandoning all unsaved changes.

The function of the soft buttons and their labels will change when editing values, such as numbers and passwords, and this is described in the following sections.

If the flowmeter enters **Setup Mode** and no input of any sort is received for a period of 5 minutes, then it will return to the **Startup State**, from which the user can re-enter the **Setup Mode**, if desired.

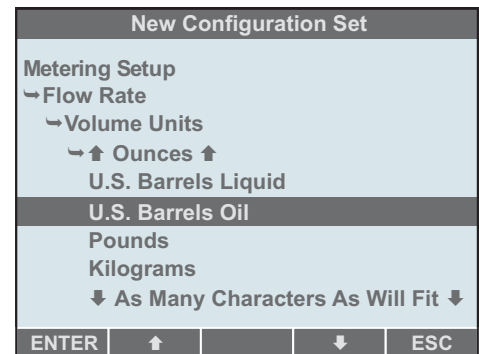

5.1.1 Setup Root Menu

The **Setup Root Menu** is shown at right. From this screen, the user can **Manage Configuration Sets** and edit certain **Global Configuration** items.

The flowmeter stores up to five sets of configuration item values, called "Configuration Sets", which are numbered from 1 to 5.

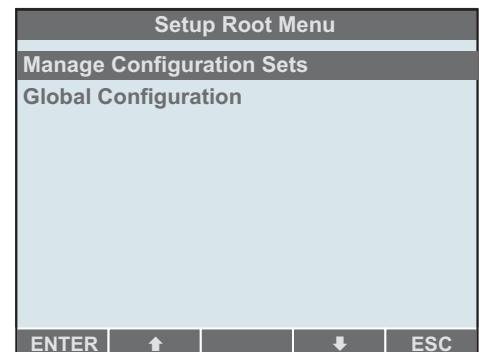

5.1.2 Escaping From Setup

If the **ESC** soft button is pressed repeatedly to go back up in a menu until the top level is reached and is then pressed one time more, the flowmeter "escapes" from the **Setup Mode** directly to the **Startup State** and from there to the **Run Mode**, as described in section 4.4 above. The **Configuration Set** used is the same as was previously selected. If no changes were made to *this* Set, for example if a different **Configuration Set** was changed, the flowmeter will operate exactly as before. However, if the *active* Set has been opened, edited and saved, then the changes will take effect *without the re-calculation of internal parameters* and therefore the flowmeter may not operate correctly.

5.2 Global Configuration

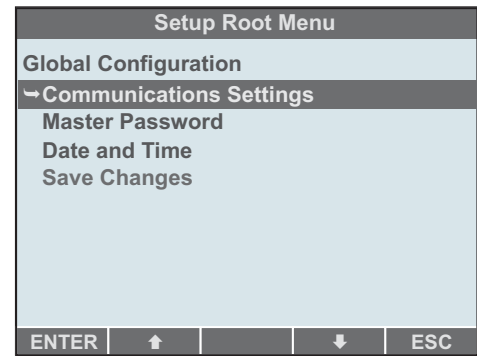
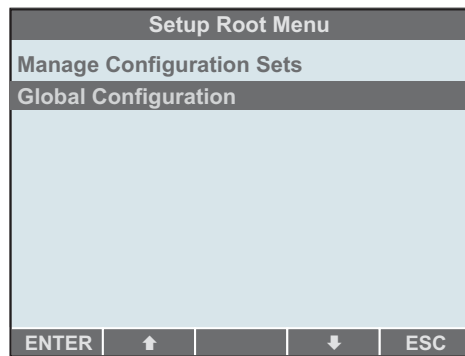

Under the **Global Configuration** menu item, you can change communications settings, enter and/or change the Master Password, set the date and time, and saving the changes.

The **Global Configuration** settings apply to the flowmeter as a whole and are not associated with numbered **Configuration Sets**. Changes take effect when you highlight **Save Changes** and press the ENTER soft button. The **Setup Root Menu** then re-appears. This may disrupt communication, depending on what changes have been made. Any changes are lost if the flowmeter loses power before the changes are saved or the user presses the **ESC** soft button until the **Setup Root Menu** returns to the top level and then one more press.

The following sub-sections explain further what happens when you highlight a choice and acts on it by pressing the **ENTER** soft button.

5.2.1 Communication Settings

Selecting the **Communications Settings** menu allows you to:

- Set the RS-232 bit rate
- Set the RS-485 bit rate and slave node address
- Set the Ethernet IP address, subnet mask, default router and UDP port number of the flowmeter

RS-232 and RS-485 will always use 8 data bits, 1 stop bit, no parity and no flow control. These settings are not configurable.

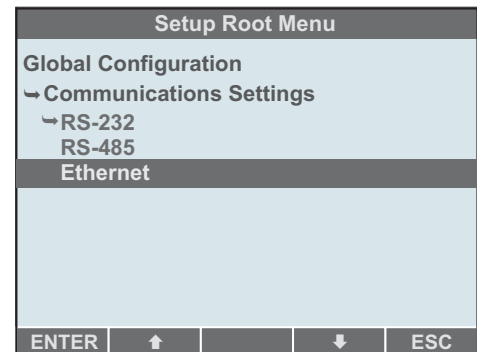

Selecting the Ethernet menu allows you to:

- Set the Ethernet IP address (the default IP Address is 192.100.100.23)
- Set the subnet mask
- Set the default router
- Set UDP (Universal Data Port) port number of the flowmeter (typically set at 26000)

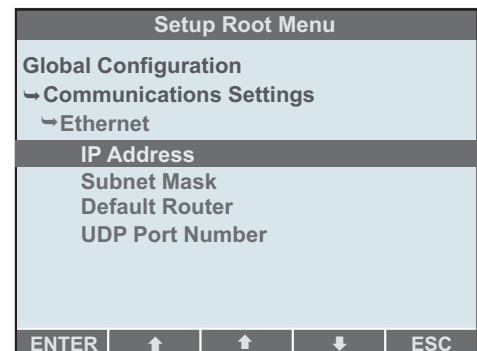

Sonic-Pro**5.2.2
Master
Password**

On selecting this action, you are prompted to supply a Master Password. **The master password is “empty” when shipped from the factory. The first time user may enter any master password.** Once entered, this master password can be used to enter ANY configuration, as if no other passwords are present.

Once a **Master Password** has been entered, upon selecting this action, you will be prompted to supply the **Master Password**. If this is done incorrectly, the flowmeter returns to the **Setup Root Menu**. If it is done correctly, you are given the choices of changing the **Master Password** or returning to the **Setup Root Menu**. If you elect to change the **Master Password**, you must enter it twice. You will receive confirmation of the change or, if the two entries were not the same, the password will not change and, in either case you are returned to the **Setup Root Menu**. Whether the **Master Password** is changed or not, on return to the **Setup Root Menu**, you will not need to enter passwords for the duration of the current **Setup Mode** session.

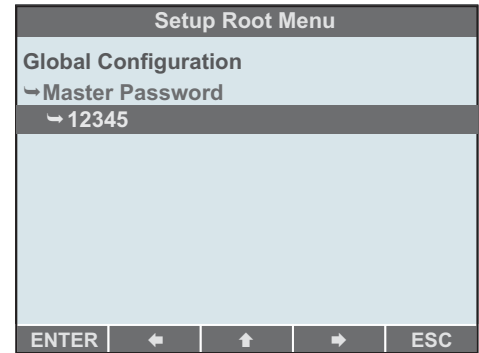

Wherever a password is required, the **Master Password** will be accepted. Therefore, knowing the **Master Password** lets you do anything. In particular, you can overwrite “forgotten” passwords. Knowing just the password of a single **Configuration Set** lets you edit, activate or delete only that set.

**5.2.3
Setting the Date
and Time**

On selecting this action, you are able to change date and time settings. Each digit can be set in the same way as for numerical data, see section 6.3.1.1 below.

The flowmeter uses date and time information to time stamp log entries, see section 7.6 below. There is no explicit means to set the time zone or daylight savings time. The clock must be manually set forwards or backwards as appropriate.

The meter includes a coin cell battery to maintain the date and time settings in the event of a power failure (Type CR1632, 3V 16mm 126mAh). The battery should last for years of operation. The battery is located on the main circuit board. Contact the factory if the battery must be replaced.

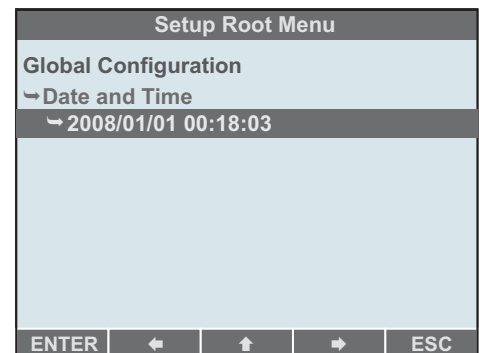
**5.2.4
Saving Changes**

Save changes before escaping from the Global Configuration menu. If the **ESC** soft button is pressed repeatedly to go back up in a menu until the top level is reached and is then pressed one time more without saving the changes, the flowmeter “escapes” from the **Setup Mode** directly to the **Startup State** and from there to the **Run Mode**.

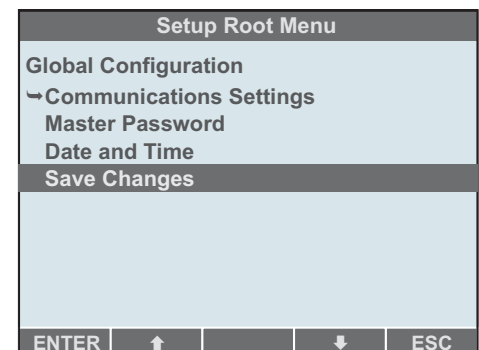

5.3 Manage Configuration Sets

Under the **Manage Configuration Sets** menu item, the user is offered actions to manage these Sets in much the same way as files on a computer.

Activate a Configuration Set allows the user to apply a Configuration Set to the flowmeter, which will then enter Run Mode and operate according to the configuration information in that Set plus the setting of the motherboard measurement mode switch.

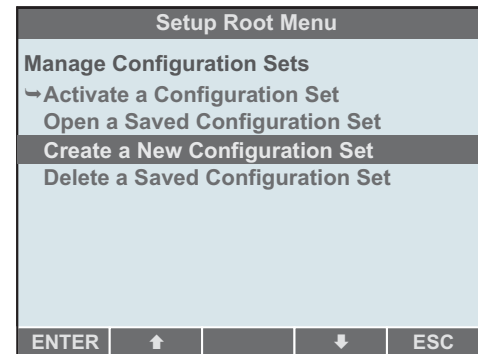



Open a Saved Configuration Set allows the user to inspect and edit a Configuration Set, reset it to the Factory Configuration, save changes to it, save it to a different Set, etc.

Create a New Configuration Set begins a fresh Configuration Set, starting from the pre-set Factory Configuration.

Delete a Saved Configuration Set removes a Configuration Set from the flowmeter.

Similar to operating on files in a computer, the editing of a **Configuration Set** takes place in a temporary location called the "Working" Set. This must be saved by the user, either back to where it came from or to a different numbered Set, otherwise it will be lost if the flowmeter loses power or the user escapes from Setup Mode.

5.3.1 Activate a Configuration Set

On selecting this action, a list of the pre-saved **Configuration Sets** will be shown. The user can select a Configuration Set using the  and  soft buttons and press the  soft button to activate that Set. The flowmeter then exits the **Setup**

Mode to the **Transducer Positioning State** and eventually the **Startup State** and then to the **Run Mode** where it will perform flow measurement using the configuration data of that **Set**.

The **Setup Root Menu** will return to the screen without the activation of a **Configuration Set** if the user fails to supply a password (if required), or presses the **ESC** soft button twice.

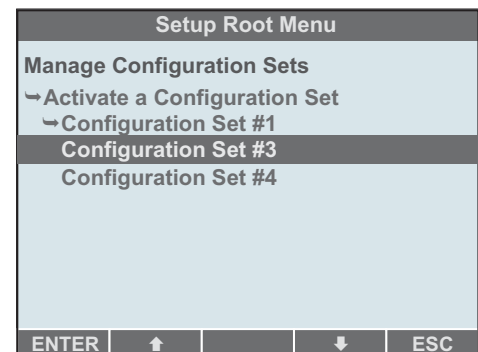

5.3.2 Open a Configuration Set

This action is similar to **Activate a Saved Configuration Set** in that the user is able to select and open a valid **Configuration Set**. On pressing the **ENTER** soft button and supplying a password if necessary, the selected **Configuration Set** will be loaded into the **Working Set** and the **Configuration Edit Menu** will appear. From this screen, the user can navigate to and edit configuration items.

5.3.3 Create a New Configuration Set

On selecting this action, the pre-set **Factory Configuration** data will be loaded into the **Working Set** and the **Configuration Edit Menu** will appear. The banner will read **New Configuration Set**. From this screen, you can navigate to and edit configuration items and save the configuration to a numbered Set.

5.3.4 Delete a Configuration Set

Deleting a **Configuration Set** starts out the same as **Activate a Saved Configuration Set**. On pressing the **ENTER** soft button and supplying a password if necessary, the **Configuration Set** number and data will be deleted. Note that new configuration data can now be saved to that numbered set). If all **Configuration Sets** are deleted, the flowmeter will operate according to the **Factory Configuration**.

5.4 Configuration Edit Menu

The **Configuration Edit Menu** appears if a new **Configuration Set** is created or if an existing **Configuration Set** is successfully opened. The banner on the top line identifies the configuration as **New Configuration Set** or **Configuration Set #1**, etc. Note that any changes made are held in a temporary “working” **Configuration Set** and are not stored to a numbered Set until the user explicitly selects this operation.

From here, the user can:

- Inspect and **Edit** the **Working Configuration Set**
- Reset everything to the **Factory Configuration**
- Create, change or delete the **Configuration Set Password**
- Save the **Working Configuration Set** to a numbered **Configuration Set**
- **Activate** the Set after saving it to a numbered **Configuration Set**
- Abandon edits and return to the **Setup Root Menu**

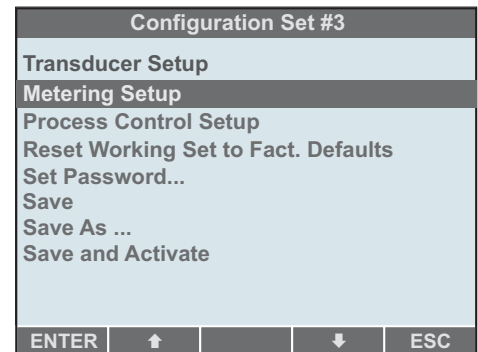



The **Working Configuration set** cannot be directly activated. It must first be saved (to a numbered Set). Actions do not appear in the menu if they are inappropriate (for example, **Save** and **Save and Activate** do not appear for a new Set until it is saved to a **Numbered Set**).

5.4.1 Editing Data Items

There are two possible ways to change editable data in the flowmeter. From the user PC software, decimal digits can be typed directly. From the flowmeter, the user is limited to the five soft buttons. Data is not available for editing in Model S1 and Models S2 without the user PC Software application.

5.4.1.1 Editing Numerical Values

If you press the **ENTER** soft button when the highlight is on a leaf item that has a editable value (rather than a list of choices), you can then edit the value, one digit at a time. The current value is displayed to an appropriate precision and the leftmost digit is highlighted (see example below).

Using the  soft button, the value of the highlighted digit can be increased by one for each press. Upon reaching 9, it wraps to 0. Using the  and  soft Buttons, the highlight can be moved to the left or right one digit at a time. The highlight skips non-editable positions, such as the decimal point. If the highlight is moved beyond the leftmost digit, a new digit will appear with the value 0. If this digit is not changed before the highlight is moved back to the right, it will be removed. A similar procedure can be used to add zeros to the right of the number, but only if the number is a real number (contains a decimal point).

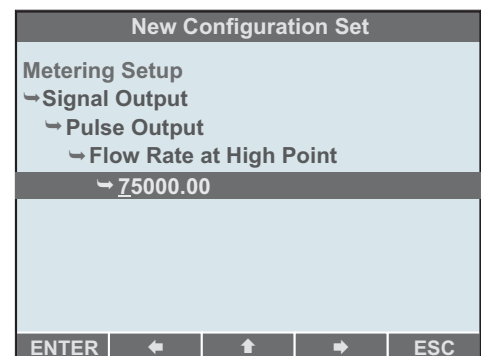

When the **ENTER** soft button is pressed, the currently displayed value becomes the new value of the item being edited and the menu system moves one place back, appearing as it did before the edit began. If the **ESC** soft button is pressed, then the menu system also moves one place back but the value of the item is not changed and remains as it was before the edit.

5.4.1.2 Entering Passwords using the Soft Buttons

All passwords must contain 5 digits. Each of the five soft buttons represent 2 digits. The numbers 5, 6, 7, 8 and 9 are interchangeable with 0, 1, 2, 3 and 4 (respectively), so only five choices are needed to enter any digit from 0 thru 9. Entering the number 00000 (55555) effectively cancels the password input or deletes an existing the password.

If you are prompted to supply a password and fail to do so within 30 seconds, the flowmeter reacts as if an incorrect password was entered.

When setting or changing a password, the password must be entered a second time to avoid entry errors. If the two entries do not match, the password will not be changed. To remove password protection, you can take the normal action to set a password and then delete it by entering the number 00000 (55555) effectively deleting the password. You are then no longer prompted to enter the password but are instead immediately given access to the protected data.

Setup Root Menu				
Manage Configuration Sets				
↳ Open a Saved Configuration Set				
↳ Configuration Set #1				
Configuration Set #2				
Configuration Set #3				
Configuration Set #4				
Configuration Set #5				
Enter Password [■ ■ ■ ■ □]				
0 / 5	1 / 6	2 / 7	3 / 8	4 / 9

5.4.1.3 Units of Measure

Many data items must be entered with reference to a specific unit of measure.

In the **Metering Setup** branch of the **Configuration Edit Menu** (see section 5.4.3 below), you are able to specify three different units of measure; two relating to *rate* of flow (Flow Rate Volume Units & Flow Rate Time Units) and one relating to *total* flow (Flow Total Volume Units). Thus, rate of flow units can be configured for GPM and total flow units can be configured for U.S. Barrels Liquid. *Note that total units do not include time as a variable.*

When entering data in the **Metering Setup** and the **Process Control Setup** screens, any value associated with *rate* of flow must be entered in the *rate of flow* units of measure that is currently configured at the time the data entry takes place. Any value associated with the *total* flow must be entered in the *total flow* units of measure configured at the time the data entry takes place. This requirement does not apply to values in the **Transducer Setup** branch, (such as pipe sizes) which are governed by a separate selection of units of measure (see section 5.4.2 below). When entering data by making a selection from a list, it is not necessary to be aware of the units of measure in force.

For example, if in Flow Rate Volume Units you chose U.S. Gallons and in Flow Rate Time Units you chose Hours, then Log Rate Setpoints must be entered in U.S. Gallons per Hour. Similarly, if in Flow Total Volume Units you chose U.S. Barrels Liquid, Log Total Setpoints must be entered in U.S. barrels liquid.

If the configured units of measure are changed, all editable data item displays will automatically change to the new units, but they will represent the same actual quantities. This happens because the flowmeter converts and stores these data values in SI units.

Sonic-Pro**5.4.2
Transducer
Setup**

The **Transducer Setup** branch of the **Configuration Edit Menu** allows you to establish the fundamental parameters of the flow meter, including the ultrasonic transducers, the pipe to which they are mounted, the liner inside the pipe, if any, and the fluid flowing in the pipe.

Using information entered here, the flowmeter calculates many “engineering” parameters that are critical to accurate measurement. This is done when a

Configuration Set is “activated”, but not when a user exits **Setup Mode** by “escaping” (for example, after the five minute timeout). Note that changes in this area of configuration followed by an escape from **Setup Mode** may cause the flowmeter to display incorrect flow information.

Under the **Transducer Setup** branch, the following actions are available:

Measurement Units allows you to specify whether dimensions will be entered in inches and the speed of sound in feet-per-second (English) or dimensions will be entered in millimeters and the speed of sound in meters-per-second (Metric). This choice and all entered numbers must be consistent when a Set is activated. If, for example, the pipe diameter is entered as 2.00 when English units are selected but the choice is then changed to Metric, it is necessary to go back and enter 50.8 as the pipe diameter or the flowmeter will attempt to configure itself for a pipe which is only 2 millimeters across (and will fault).

Transducer --> Model Number allows you to specify the model number of the transducer pair used. You should not change this setting unless you use a different transducer pair from that originally supplied. The transducer model number (A00 through A20) is printed on the transducer housing.

Transducer --> Mount Method allows you to specify the transducer mount method used when the meter is set for Transit Time measurement mode. The options are “Z” mount (transducers on opposite sides of the pipe, no reflections of the sound wave on the pipe wall), “N” mount (transducers on opposite sides of the pipe, two reflections of the sound wave on the pipe wall), “V” mount (transducers on the same side of the pipe, one reflection from the far wall), “W” mount (transducers on the same side of the pipe, two reflections from the far wall). See section 6.0.

Pipe Outside Diameter allows you to specify the outside diameter of the pipe.

Pipe --> Wall Thickness allows you to specify the thickness of the pipe wall. From this and the outside diameter, the flowmeter calculates the inside diameter and hence the cross-sectional area of the pipe. This is critical to converting the measured velocity of the fluid to a volumetric flow.

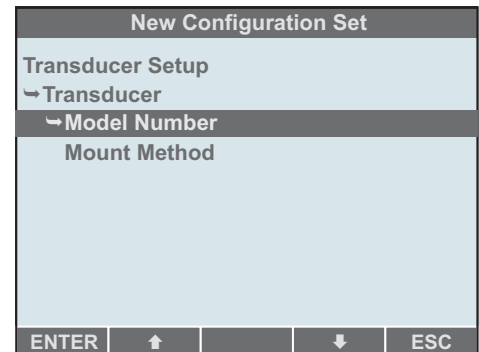
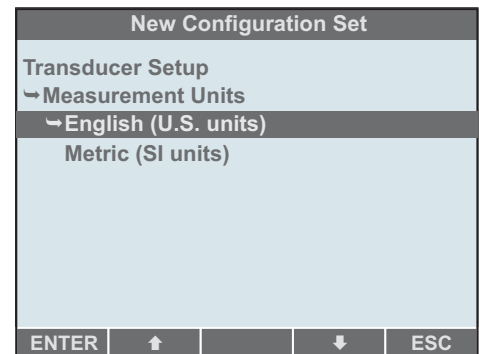
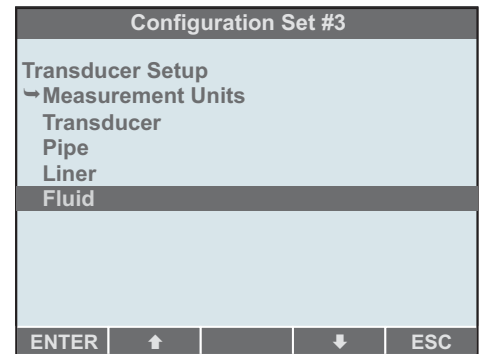

5.4.2 Transducer Setup (continued)

Pipe --> Pipe material allows you to select from a list the material from which the pipe is made. This tells the flowmeter the speed-of-sound in the pipe wall. The user can also select **Custom Pipe Material** in the list and use the **Pipe --> Speed of Sound in Custom Material** to enter the speed-of-sound directly. This alternative should be used if the correct pipe material is not in the list offered.

Liner --> Wall Thickness allows you to specify the thickness of any liner inside the pipe. If there is no liner in the pipe, it should be set to zero.

Liner --> Speed of Sound allows you to specify the speed-of-sound in the liner material. If there is no liner in the pipe, it is not necessary to set this as it will be ignored.

Fluid --> Fluid Type allows you to select the type of fluid in the pipe from a list. This tells the flowmeter the speed-of-sound in the fluid. The user can also select **Custom Fluid Type** in the list and use the **Fluid --> Speed of Sound in Custom Fluid** to enter the speed-of-sound directly. This alternative should be used if the correct fluid or fluid/temperature combination is not in the list offered.

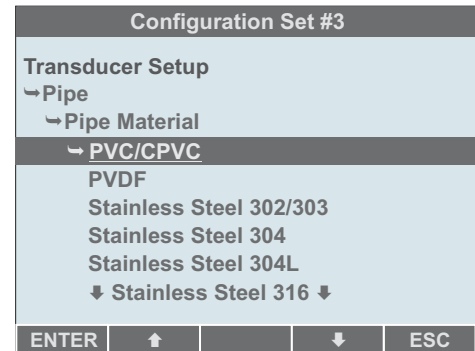

5.4.3 Metering Setup

The **Metering Setup** branch of the **Configuration Edit Menu** allows you to select how the flowmeter will display, record and otherwise process flow measurements, including the units of measure, averaging, frequency of update, scaling at signal outputs and logging.

Changes in this area of configuration affect only the way in which the flowmeter presents flow information on the display, at output signals and in logging. This will not cause the flowmeter to make incorrect flow measurements.

Under the **Metering Setup** branch, the following actions are available:

Flow Rate --> Volume Units allows you to specify the units of measure in which flow rates are displayed and written to log entries. You can also select **Custom Volume Units** in the list and use the **Flow Rate --> Custom Volume Unit** per U.S. Gallon to enter the equivalent of one U.S. Gallon in that unit. This alternative should be used if the desired unit of measure is not in the list offered.

Flow Rate --> Time Units allows you to select the time part of the units of measure for flow rates. The options available are seconds, minutes, hours and days.

Flow Rate --> Digits After Decimal Point allows you to specify how many digits appear after the decimal point when flow rate is displayed on the Run Mode screen.

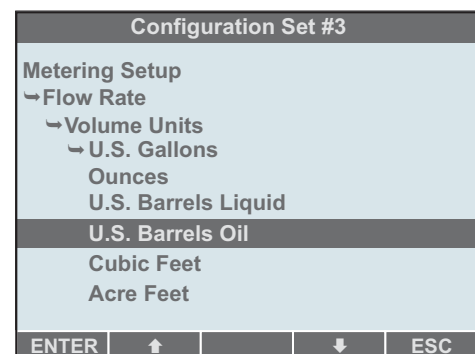
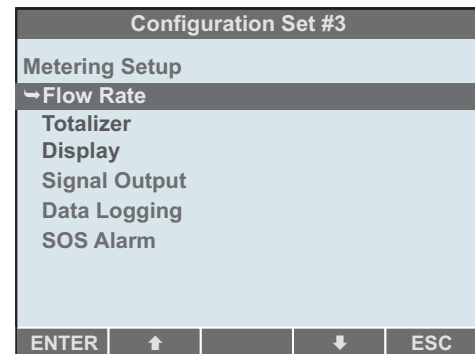

Sonic-Pro**5.4.3
Metering
Setup
(continued)**

Flow Total --> Volume Units allows you to specify the units of measure in which flow totals are displayed and written to log entries. This is independent of the units of measure for flow rates, so that the flow rate units of measure may be different than the flow total units. As for **Flow Rate**, a custom unit of measure can be specified.

Flow Total --> Digits After Decimal Point allows you to specify how many digits appear after the decimal point when flow total is displayed on the Run Mode screen.

Flow Total --> Total Display Function allows you to enable or disable the clearing of the recorded total flow using the **CLEAR** soft button on the display in **Run Mode** and also the clearing of batch counts and totals on **Process Control Screens**.

Display --> Display Language allows you to select the natural language of display text. The choices offered are English, Spanish, German and French.

Display --> Flow Rate Averaging allows you to select the time interval over which flow rate measurements are averaged before presentation to the display, signal outputs, process control, logging, etc. The choices offered are 0.25, 0.50, 1.00, 2.50, 5.00 and 10.00 seconds. Longer values result in higher accuracy and a more stable display but a slower response to changes in flow rate. The Flow total value is not affected by flow rate averaging setting.

Display --> Display Update allows you to select the time interval between the presentation of new flow information to the display, signal outputs, process control, logging, etc. The choices offered are 0.25, 0.50, 1.00, 2.50 and 5.00 seconds. Both flow rate and flow total are affected.

Display --> Low Flow Cutoff allows you to specify a flow rate below which the actual measured value is replaced by zero. When factory configured, a flow rate equal to approximately .25 feet per second is set.

Display --> High Flow Cutoff allows you to specify a high rate above which the actual measured value is replaced by the cutoff value. When factory configured, a flow rate equal to approximately 30 feet per second is set.

Display --> Scaling Offset allows you to specify a scaling factor, which would generally be close to one, by which measured flow is multiplied. If required, this value can be used to quickly adjust for errors in the flow rate reading after a field calibration has been performed.

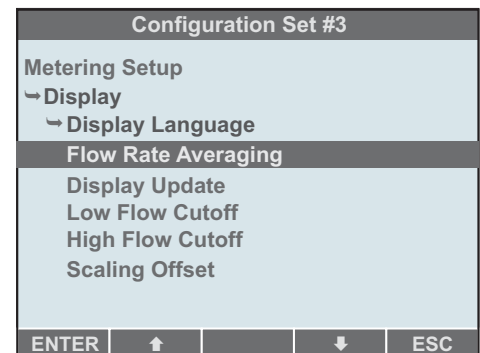
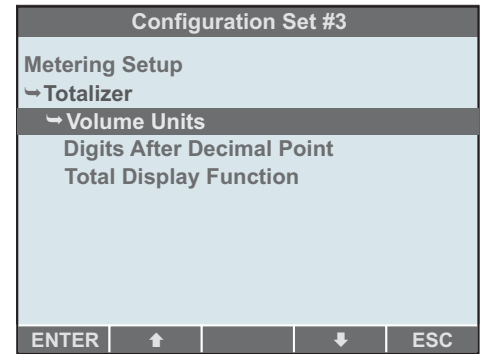

5.4.3 Metering Setup (continued)

Signal Output --> Analog Output allows you to specify the mapping of flow rate to the current value at the 4 to 20 mA analog output signal. The mapping is specified by two points on a straight line.

Signal Output --> Pulse Output allows you to specify the mapping of flow rate to the frequency of pulses at the digital output signal. The mapping is specified by two points on a straight line.

Data Logging --> Log Interval allows you to specify a regular periodic interval in seconds, at which flow rate and flow total will be recorded in a log entry. The factory default setting is 180 seconds. (see section 7.6 below for more on data logging).

Data Logging --> Log Rate Setpoint allows you to specify upper and lower flow rates which, when crossed, will result in log entries being generated.

Data Logging --> Log Total Setpoint allows you to specify five total flow values at which log entries will be generated.

SOS Alarm --> Percent Error Window allows you to define the percentage of fluid sound speed change that is acceptable before an error alarm is triggered. The default value is 10%. See the index at the back of this manual for fluid sound speed data.

SOS Alarm --> Error Type allows you to define the type of error that will result when the measured fluid sound speed has exceeded the limit window. When **Warning** is selected, the meter will log and display a warning and flow measurement will continue. When **Fault** is selected, the meter will log and display a fault condition, flow measurement will cease, and the meter will enter the faulted state. See section 4.8 for information on faults and warnings.

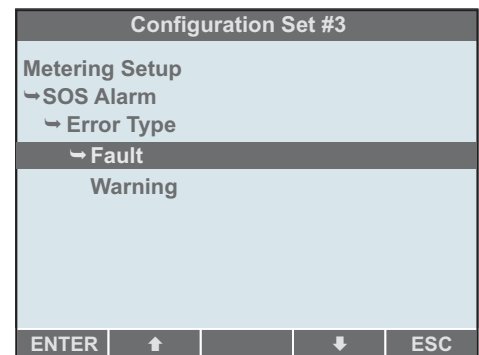
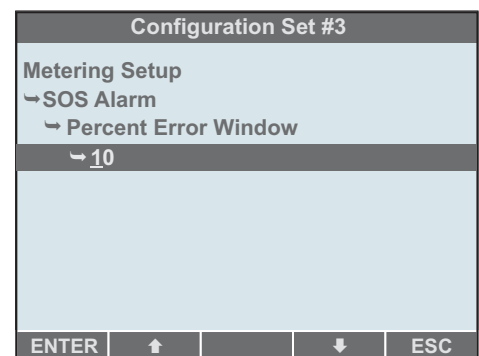
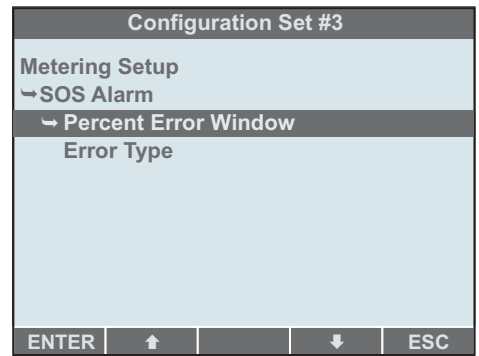
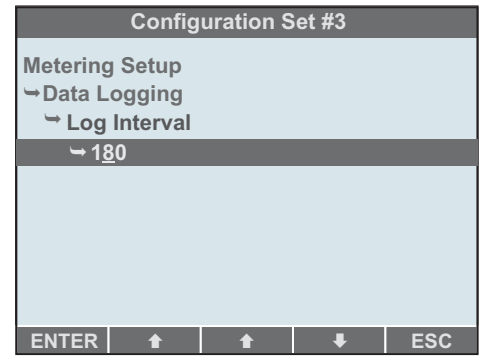
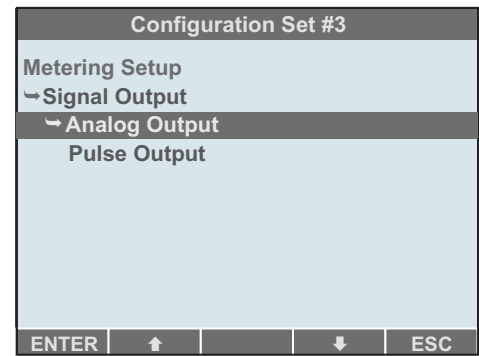

Sonic-Pro**5.4.4
Process
Control
Setup**

The **Process Control Setup** branch of the Configuration Edit Menu allows you to assign each of the three Relay Channels to monitor either the flow rate, flow total, error codes, or be disabled and also to establish appropriate process control settings.

For a detailed description of the flowmeter Process Control functions and the precise effect of each setting briefly presented here, see section 8 below.

Under the **Process Control Setup** branch, sub-branches appear for each of the three Relay Channels.

Under the sub-branch for each Relay Channel, the following actions are available:

Assign Relay allows you to assign the channel to monitor flow rate, flow total, error codes or to be disabled.

Flow Rate Alarm Settings --> High Trigger allows you to enter a flow rate at and above which the channel will generate an alarm condition.

Flow Rate Alarm Settings --> High Release gives you the option of entering a flow rate at which an alarm condition generated by reaching the high trigger value will automatically clear.

Flow Rate Alarm Settings --> Low Trigger allows you to enter a flow rate at and below which the channel will generate an alarm condition.

Flow Rate Alarm Settings --> Low Release gives you the option of entering a flow rate at which an alarm condition generated by reaching the low trigger value will automatically clear.

Flow Rate Alarm Settings --> Alarm Delay Time gives you the option of entering a delay after the detection of an alarm condition during which the relay is prevented from energizing, giving the operator a chance to correct the condition.

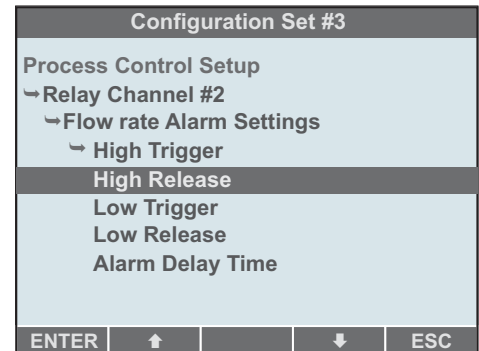
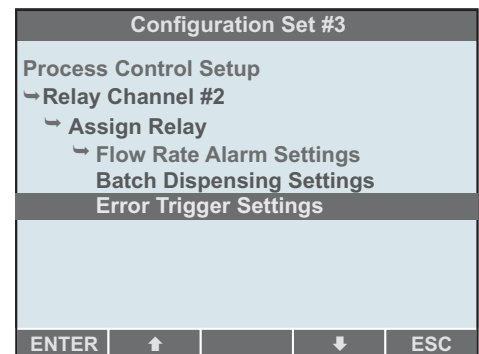
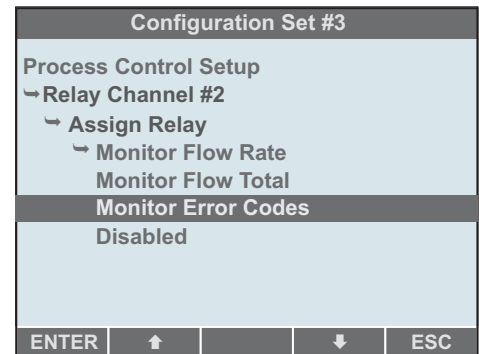

**5.4.4
Process Control
Setup
(continued)**

Batch Dispensing Settings --> Default Batch Amount allows you to set a default batch volume for the relay channel. On the **Process Control** run screen for this channel, the user is able to change the batch volume. Values edited on that screen are not saved in the **Configuration Set** and the default will be restored if the flowmeter restarts.

Batch Dispensing Settings --> Batch Start Mode allows you to select the batch start mode to be manual (the relay is manually energized by pressing the front panel soft button, remains energized until the batch amount has passed through the flowmeter and then de-energizes) or automatic (every time the batch amount is observed to pass through the flowmeter, the relay energizes for a configured time and then de-energizes).

Batch Dispensing Settings --> Relay Timer allows you to specify the time for which the relay energizes for each batch in automatic batch start mode.

Error Trigger Settings --> Type of Trigger allows you to specify the type or error that will trigger an alarm and energize the relay. Faults and warnings are described in section 4.8.

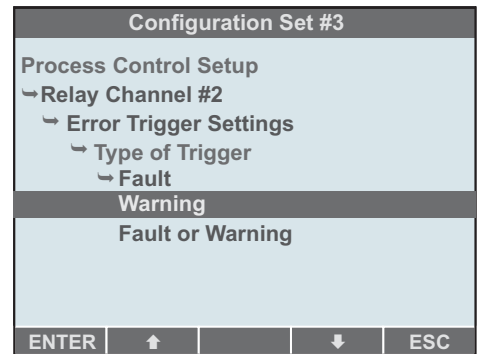
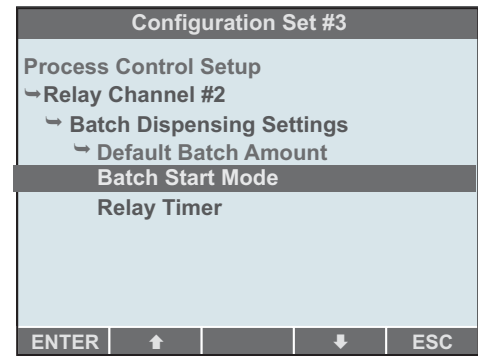

Sonic-Pro**5.4.5
Reset Working
Set to Factory
Values**

If you select **Reset Working Set to Factory Values** from the Configuration Edit Menu, then all configuration items that are editable are set to values established by the **Factory Configuration**. The prompt *Are you sure? (You will lose all information in the Working Configuration Set)* appears and soft buttons are assigned to **YES** and **NO**. If the **Configuration Edit Menu** was reached by opening a saved configuration set, the additional information (Configuration Set # 3 will not be affected) will be displayed, as appropriate. If the user presses the **YES** soft button, the **Working Set** will be reset, otherwise it will not. In either case, the **Configuration Edit Menu** re-appears.

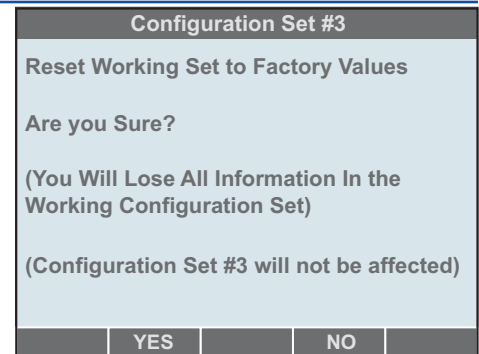

**5.4.6
Set Password
(for a single
configuration
set)**

If you select **Set Password** from the Configuration Edit Menu, then a password can be set or cleared for the Working Configuration Set. The prompt **Enter five-digit password**, appears. Once five soft buttons have been pressed, you will be asked to repeat the password to guard against entry errors. To escape from setting a password, it is sufficient to deliberately enter two different sequences.

When this is completed, the **Configuration Edit Menu** returns. If you have created a new configuration and attempt to save the Working Set to a previously numbered Configuration Set, then you will be prompted for the password of that Set, if one exists, before it is overwritten. If you opened an existing Set, then you must have supplied the password at that time and no further security measures are taken.

**5.4.7
Saving
Changes**

If you select **Save** from the Configuration Edit Menu, the Working Set is saved to the currently opened numbered Set. If you created a new configuration and has not previously saved it to a numbered Set, this selection is not available. You must use **Save As ...**, see below.

If you select **Save As ...** you are offered the five numbered Configuration Sets as choices as shown at right. You should use the  the  and soft buttons, to select the desired Set and press the **ENTER** soft button to save the **Working Set** to that Set. The **Configuration Edit Menu** returns. The **ESC** soft button returns to the **Configuration Edit Menu** without saving the **Working Set**.

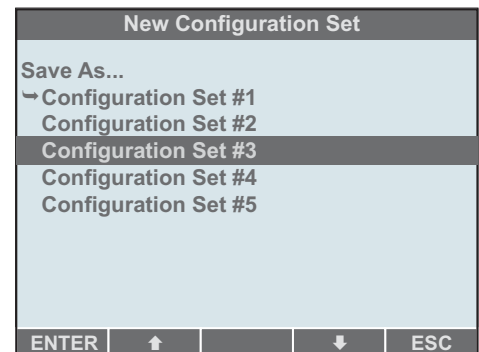

If you select **Save and Activate**, what happens is as for **Save** above, but after the **Working Set** is saved it is activated and the flowmeter exits the **Setup Mode** towards **Run Mode**.

When you attempt to save the **Working Set** to a numbered Set that is not the one originally opened for editing, then if the destination Set has a password, you will be required to supply it before the Set is overwritten.

**5.4.8
Escape Without
Saving**

If the **ESC** soft button is pressed repeatedly until all **Configuration Edit Menu** branches are closed and is then pressed one further time, the flowmeter takes the "escape" path out of **Setup Mode** directly to **Startup**. Any changes made that have not been saved are lost.

6.0 Transducer Installation

6.1 Transducer Piping System Location

Select a pipe location that provides a minimum straight length of pipe of at least 10 times the pipe's nominal pipe size and mark a point that is at least 5 times the pipe diameter downstream from the nearest pipe fitting. See section 1.6 for the minimum straight pipe length requirements.

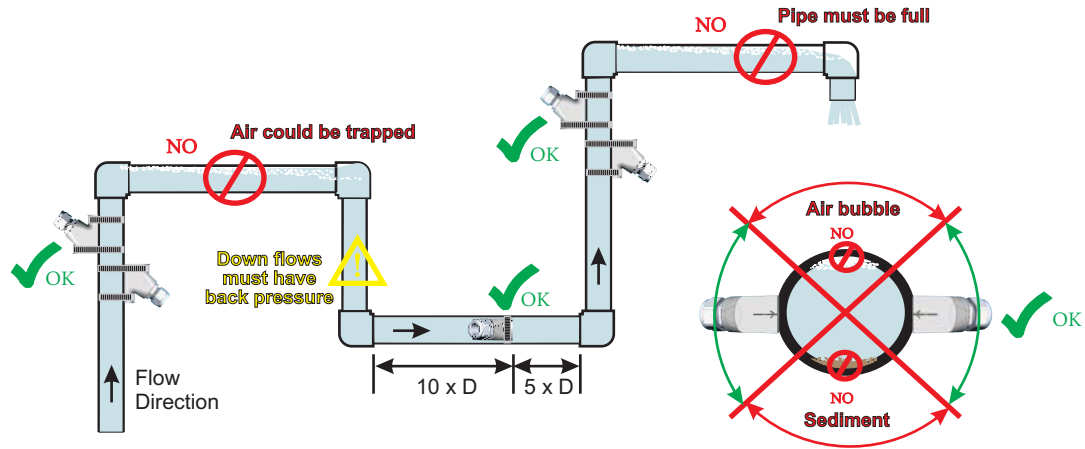

TRANSDUCER MOUNTING LOCATION

6.2 Transducer Mounting Mode for Doppler Measurement

If the fluid to be measured contains particles, the meter should be operated using the Doppler measurement method. For Doppler operation, the transducers will be mounted directly opposite each other as shown below.

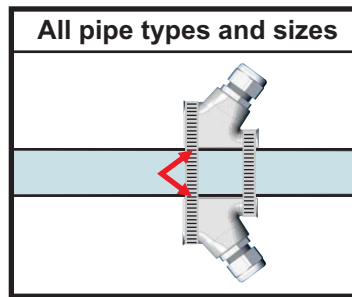

DOPLER MOUNTING MODE

6.3 Transducer Mounting Mode for Transit Time Measurement

If the fluid contains little or no particles (up to 10% maximum), operate the meter using the Transit Time method to obtain the best accuracy. Select "V" mounting mode when possible. The "V" mounting mode allows the greatest sound travel distance while permitting good signal strength. Basic pipe material and size general guidelines are shown below.

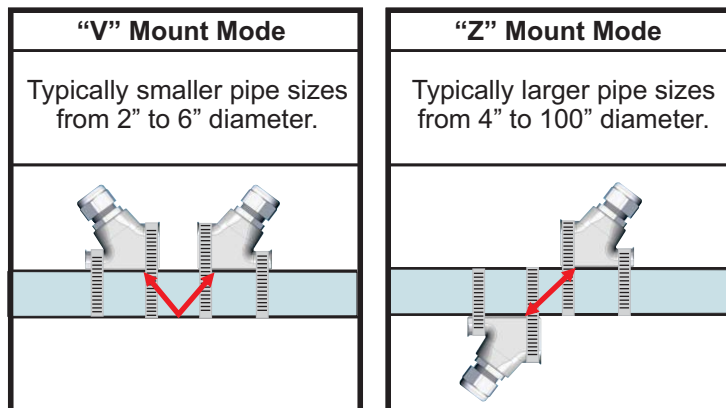

TRANSIT TIME MOUNTING MODES

Sonic-Pro

**6.4
Transducer
Separation
Distance**

When the meter is operated in the **Doppler** measurement method, the transducers are ALWAYS mounted directly opposite each other. The separation is therefore zero.

When the meter is operated in the **Transit-Time** measurement method, the front faces of the transducers must be positioned the correct distance apart.

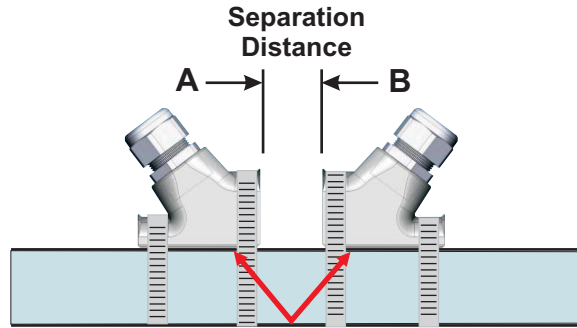

The correct separation distance is dependent on the pipe size, pipe type and chosen mounting mode. When factory configured, the separation distance and mounting mode is printed on the serial label. If the meter has not been factory configured, or if a new configuration is required, the pipe size, pipe type and mounting mode configuration data must be input before proceeding. See section 5 for instructions on how to create or modify a configuration.



For meters so equipped, the separation distance (as calculated based on the currently active configuration set) is also shown on the LCD display and on the Remote Communications PC Software display screen.

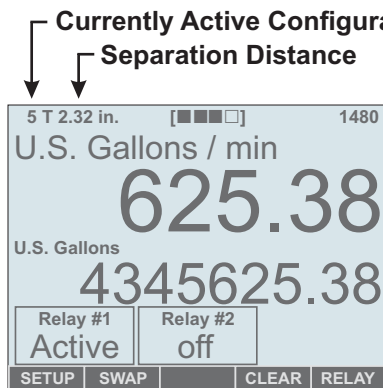

LCD Display Screen

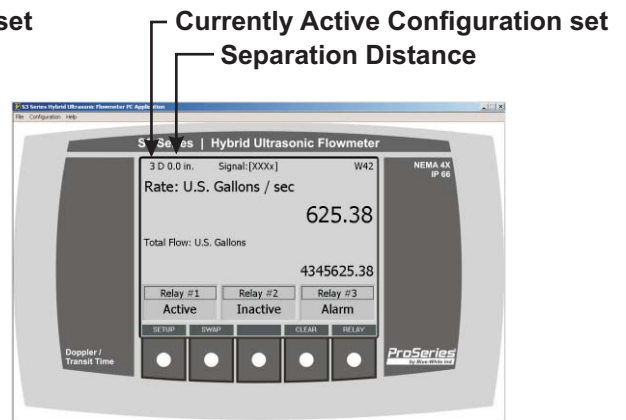

Communications PC Software Screen

6.5 Pipe Surface Preparation

The pipe mounting surface must be clean, smooth and free of any surface imperfections. Remove all insulation material, loose paint, coatings, etc. Clean the pipe surface thoroughly. Use sandpaper if necessary to remove surface imperfections. Do not mount the transducers over weld seams.

Place a mark on the pipe where the first transducer will be located. Be sure to locate the transducers on the side of horizontal runs of pipe.

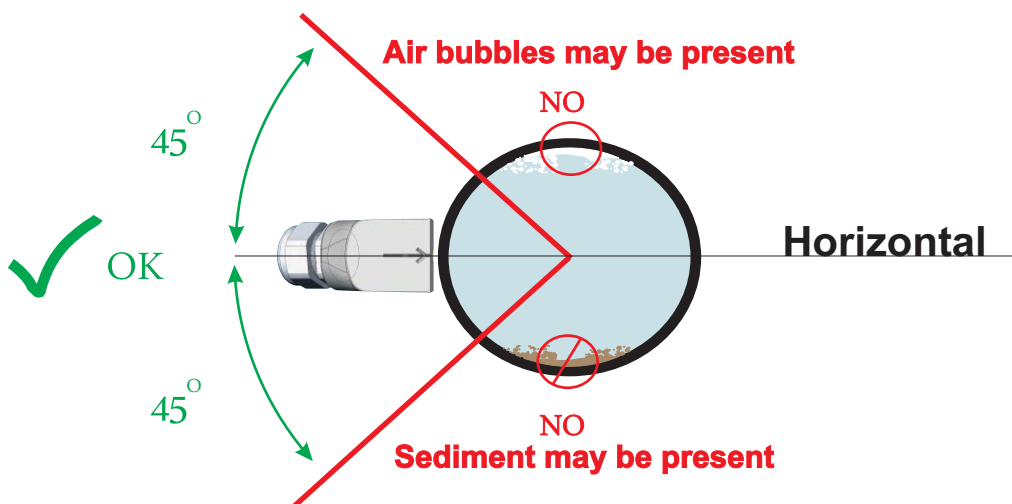

6.6 Doppler Method Transducer Installation

Doppler Mode:

If the fluid to be measured contains particles, the meter should be operated using the Doppler measurement method. For Doppler operation, the transducers will be mounted directly opposite each other as shown below.

When the meter is operated in the Doppler mode, marking the second transducer location is not necessary. Simply install both transducer directly opposite from each other.

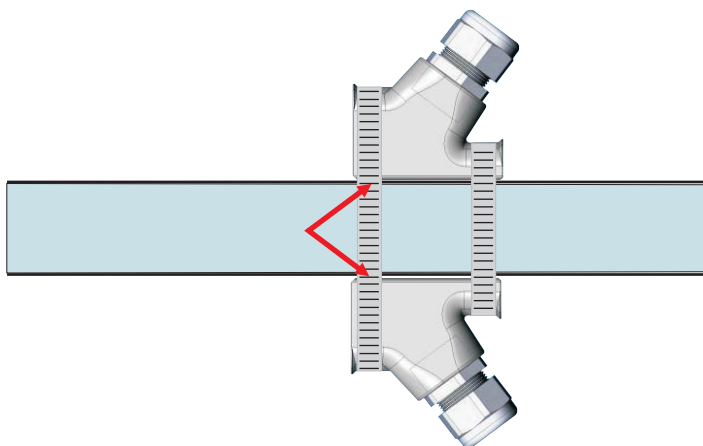

DOPPLER MOUNTING MODE

Sonic-Pro**6.7
Transit Time
Transducer
Installation
V Mount Mode****Transit Time V mounting method:**

If the fluid contains little or no particles (up to 10% maximum), operate the meter using the Transit Time method to obtain the best accuracy.

When the meter is operated in the Transit Time method, marking the second transducer location is required.

The V Mount mode requires careful separation distance measurements. Inaccurate placement of the transducers may result in insufficient signal strength and poor measurement accuracy.

Draw a straight centerline, parallel to the center line of the pipe, from the first transducer location mark (A) through to the second transducer location (B). Place a mark on the centerline at the correct transducer separation distance.

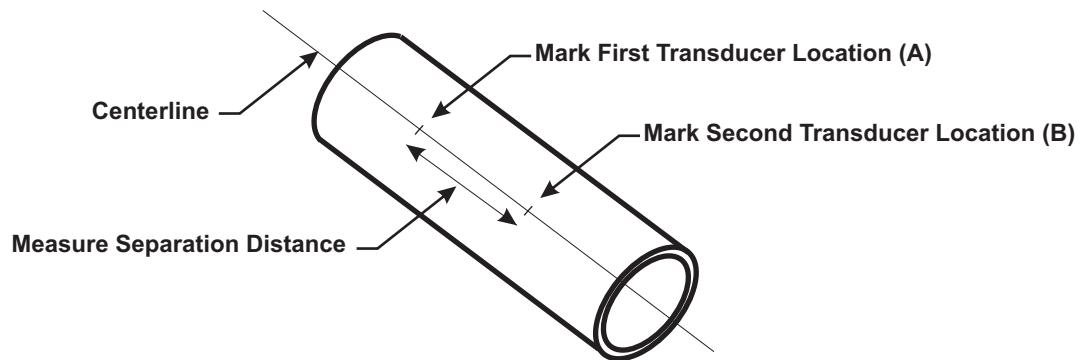
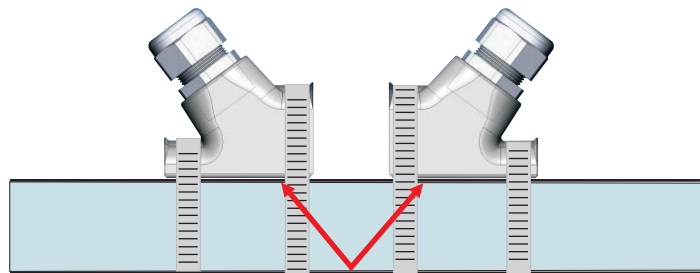
**TRANSIT TIME V-MOUNT MODE****V-MOUNT MODE**

6.8 Transit Time Transducer Installation Z Mount Mode

Transit Time Z-mount method:

The Z-mount configuration requires that the second transducer be located directly opposite the V-mount location (point B). The Z-Mount method requires careful separation distance measurements. Inaccurate placement may result in insufficient signal strength and poor accuracy.

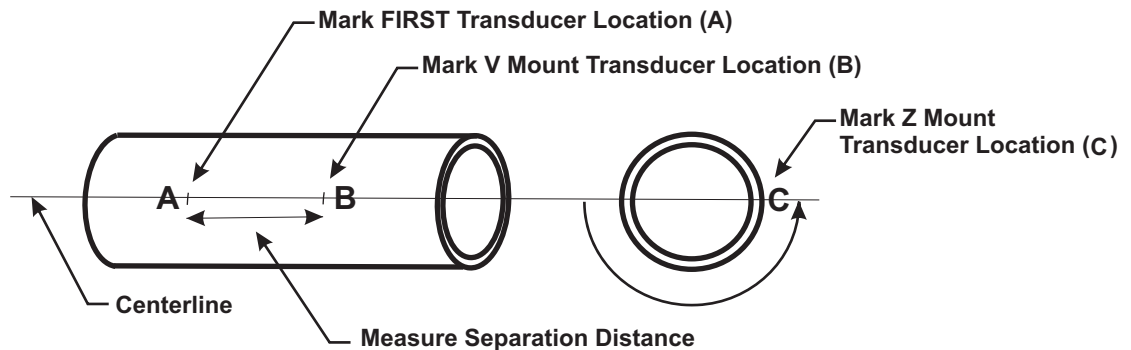

TRANSIT TIME Z-MOUNT MODE

Draw a straight centerline, parallel to the center line of the pipe, from the first transducer location mark (A) through to the second transducer location (B). Place a mark on the centerline at the correct transducer separation distance.

To locate the opposite mounting point, gift wrapping paper, butcher paper or similar paper that is long enough to wrap completely around the pipe, is required. The paper used must have squared edges.

- 1) Measure the pipe circumference by wrapping the length of paper around the pipe.
- 2) Align the overlapping side edges of the paper with each other.
- 3) Mark the paper at the point where the top edges overlap. The distance from the top edge to the overlap mark will be the pipe circumference.

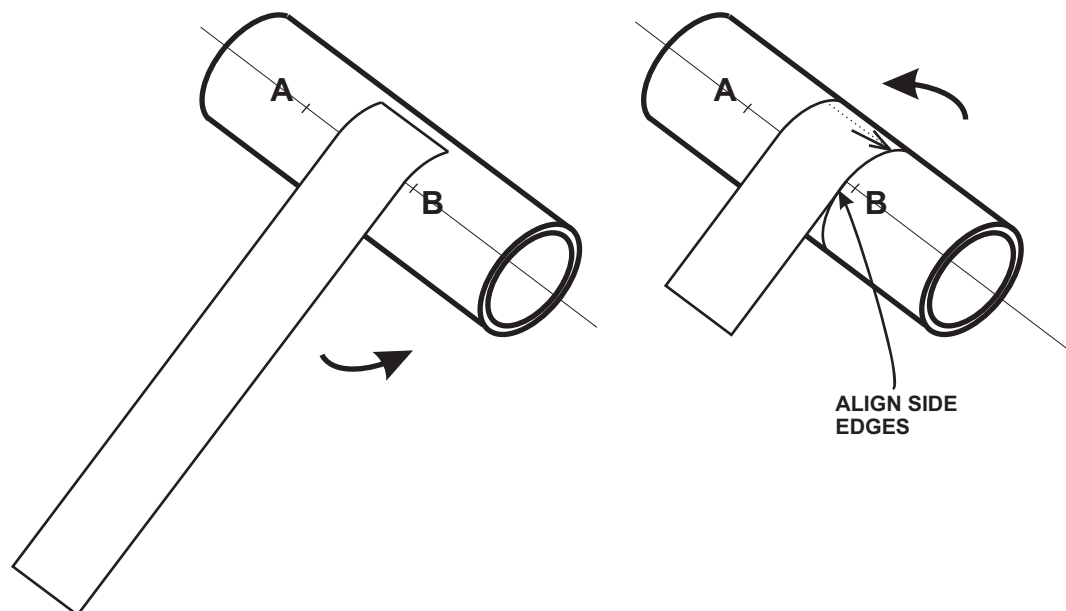

- 4) Fold the paper so that the top edge and the marked circumference point touch.
- 5) Unfold and place a mark on the folded edge. This mark will be exactly one half of the circumference. This mark is the location for the second transducer.

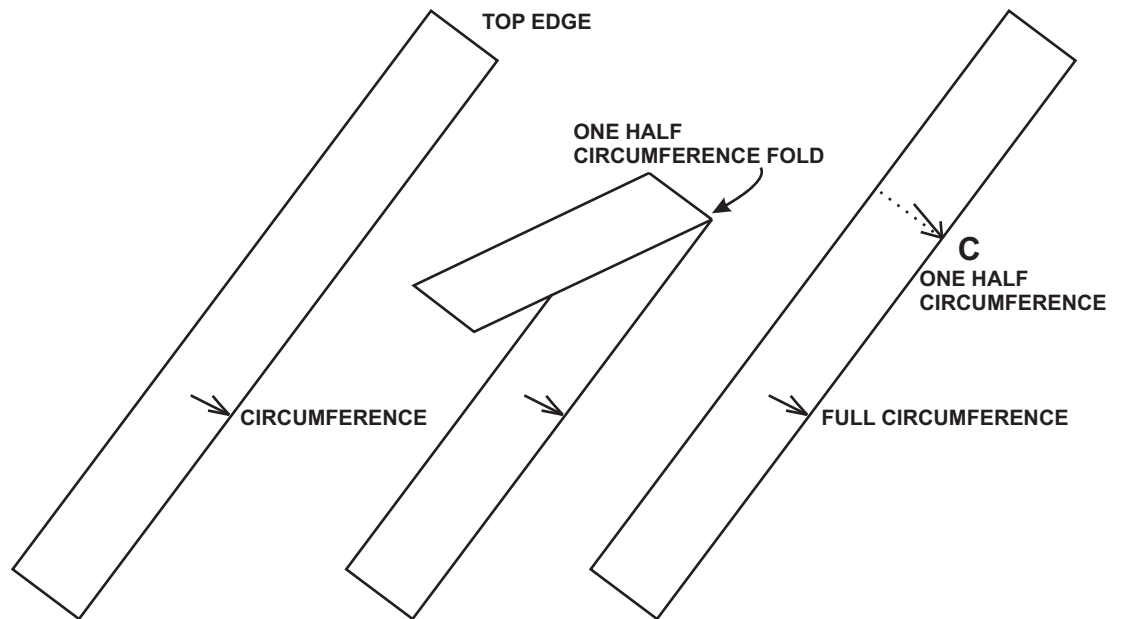

- 6) Once again, wrap the paper around the pipe starting with the top edge corner positioned at the second transducer location (separation distance point B).
- 7) Align the side edges of the paper.
- 8) Place a mark on the pipe at the one half circumference mark.

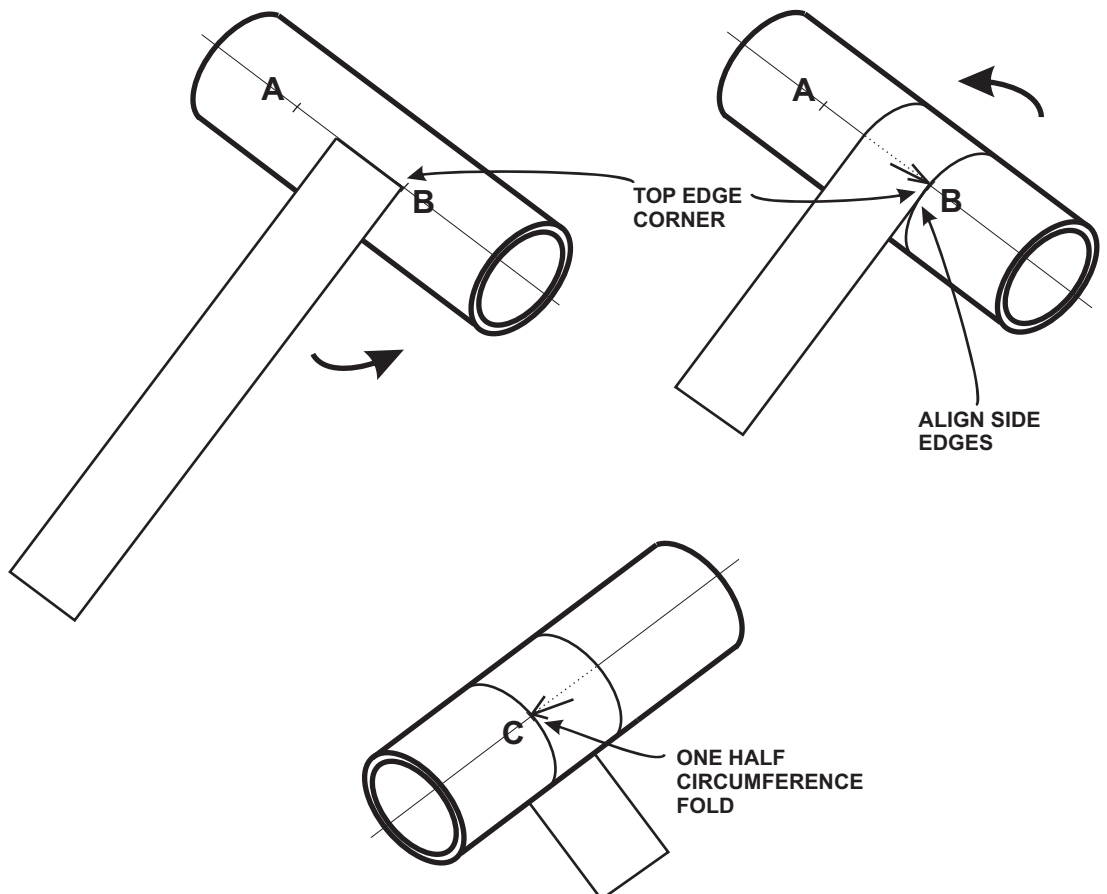

6.9 Transducer Acoustic Mounting Gaskets

An acoustic coupling material must be placed between the transducer and the pipe surface at the point where the sound waves enter the pipe. Without this material, the ultrasonic sound waves will not penetrate into the pipe. The Sonic-Pro meter package includes three different gasket materials for this purpose.

The blue gasket (part number 76001-417) should be used for permanent installations. This gasket will be damaged by repeated installations.

The white gasket (part number 90006-610) should be used for non-permanent installations such as in portable applications. This gasket will withstand multiple installations.

Dow Corning Silicone Seal #111 (part number 90008-394) may be used in place of the gaskets if desired.

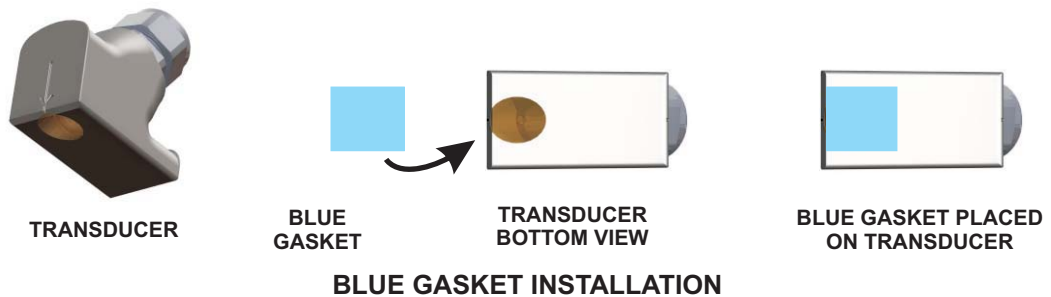

- 1) Peel off the thin paper backing from the blue gasket and place the gasket on the transducer completely covering the waveguide.
- 2) Remove the thick plastic backing from the gasket before positioning the transducer on the pipe.

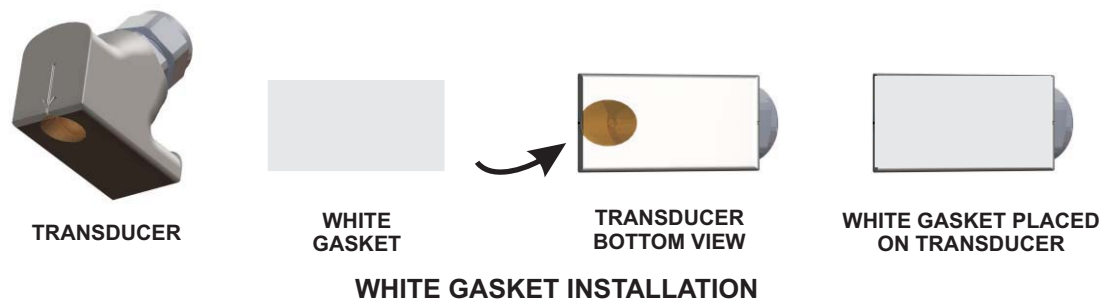

The white gasket does not include backing tape. Position the gasket on the transducer completely covering the entire bottom surface of the transducer.

6.10 Transducer Mounting Clamps

The meter is provided with five pipe clamps, four to be used for transducer mounting and a fifth for mounting the SPU. A single clamp can be used on a pipe diameter of up to 10 inches. The clamps can be chained together if required for larger pipe diameters. Additional clamps can be purchased from the factory.

Carefully place the first transducer onto the pipe so that the front arrow on the transducer is located exactly over the first separation distance mark (A). Be sure the transducer is placed straight and parallel to the pipe centerline.

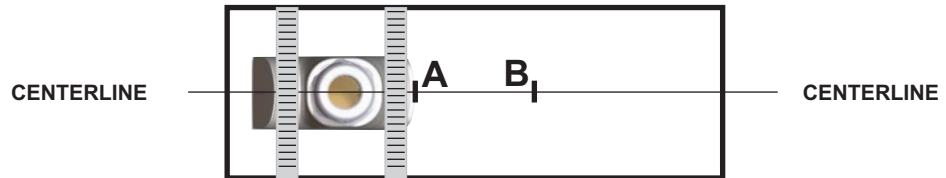

Secure the first transducer to the pipe using the enclosed pipe clamps. The arrows on the front and rear of the transducers must point toward the pipe centerline mark.

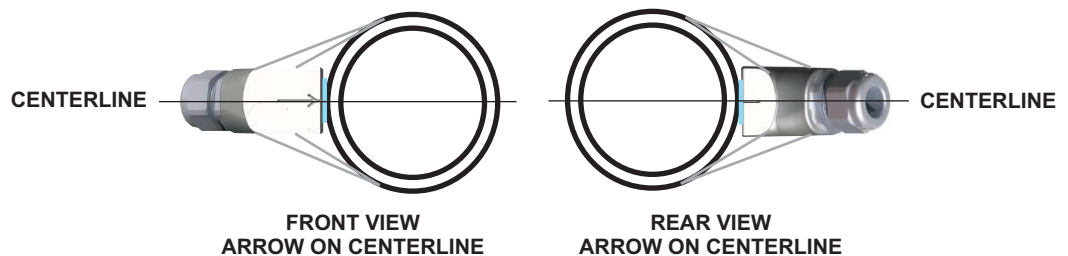

Locate the second transducer separation mark (B). Carefully place the second transducer onto the pipe so that the front arrow on the transducer is located exactly over the mark (B). Be sure the transducer is placed straight and parallel to the pipe centerline. Be sure that both transducers are facing each other and parallel to the pipe centerline.

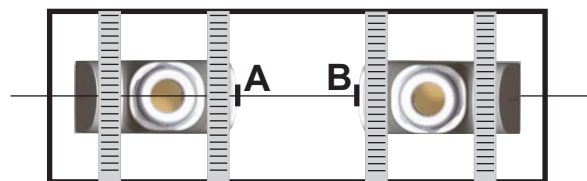

Check that the separation distance is correct. Tighten the clamps equally.

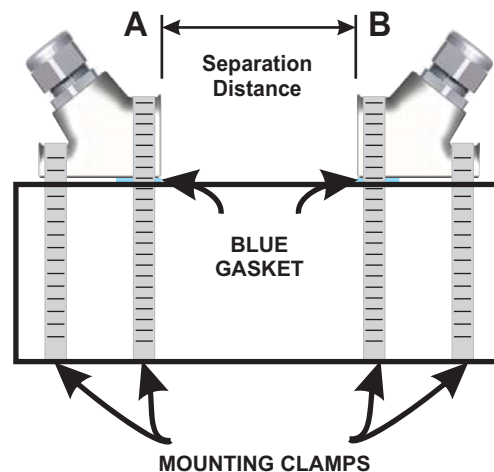

7.0 Run Mode

This section describes the flowmeter operation in the **Run Mode**. A mock-up of the **Run Mode** screen is shown at right. This is how it appears for Model S2 and S3 Displays or if it is viewed from the User PC Software application. For Model S2, the only difference is that the **SETUP** and **RELAY** soft buttons are absent (blank) on the flowmeter display (but they are still present at the PC).



In the **Run Mode**, the flowmeter measures the velocity of fluid movement in the pipe and from this, and the user-specified dimensions of the pipe, determines the volumetric flow rate and accumulates the total volume of fluid flow. The flowmeter is not sensitive to the direction of fluid movement and *flow in either direction is treated as positive* for both flow rate display and accumulation of the total volume of fluid that has passed (totalization). Should fluid flow first in one direction and then return in the other direction, the flowmeter will register a total of twice the amount of fluid, even though the net actual flow is zero.

7.1 Primary and Secondary Display Areas

Two display areas are provided to show the current flow rate and the total accumulated flow. Both areas can display ten digits and the decimal point.

You may configure the number of digits that appear after the decimal point in each display area (see section 5.4.3 above). Digits remaining (from the maximum of ten) are available for digits to the left of the decimal point. Leading zeros are not shown. If it is not possible to display the value as configured, for example if only five digits are available to the left of the decimal point and the value reaches 100,000, then the display automatically switches to engineering notation. Seven significant digits are displayed followed by "E" a two digit exponent value. Example: 2.09E12

Above the primary and secondary display areas are the primary and secondary display labels. These show whether the area is displaying flow rate or total accumulated flow and the units of measure (which are configured by the user in Setup Mode, see section 5.4.3 above).

Pressing the **SWAP** soft button exchanges the flow rate and total accumulated flow readings between the primary and secondary display areas. The labels are also exchanged. This soft button is present on Model S2 and Model S3 displays.

Pressing and holding the **SWAP** soft button exchanges the flow rate display to velocity units. If the **Measurement Units** set in **Transducer Setup** above (section 5.4.2) are in English U.S units, the velocity will be displayed as feet per second. If the Units of Measure are set as Metric SI units, the velocity will display in meters per second. Pressing and holding the **SWAP** soft button a again changes the flow rate display back to the units of measure as specified in section 6.3.3. This soft button is present on Model S2 and Model S3 displays.

Pressing the **CLEAR** soft button zeros the total accumulated flow reading, in whichever display area it is showing. The previous total is lost and flow now accumulates in a new total. This soft button is present on Model S2 and Model S3 displays. This feature can be disabled by configuration, in which case the CLEAR soft button will not appear.

Sonic-Pro**7.1.1
Flow Rate
Measurement**

The rate of fluid flow in the pipe is measured by the flowmeter many times per second. To improve accuracy and the stability of the display, these measurements are averaged over a configurable time and new values are presented to the display at a configurable rate.

The averaging algorithm used is the Simple Moving Average (SMA), which is “the un-weighted mean of the previous n data points”. Rather than selecting n, you can configure Flow Rate Averaging to be performed over some number of seconds. All measurements taken during that period are averaged to form each displayed flow reading. The averaging time can be configured by selecting a value of 0.25, 0.5, 1, 2.5, 5 or 10 seconds from the list.

The time period at which the flowmeter display updates is configurable in **Setup Mode** to 0.25, 0.5, 1, 2.5 or 5 seconds. Each time the display is updated, the SMA of the flow measurements is computed and written to the display as described above. Setting the display update period to be much greater than the averaging time may not make sense. For example, averaging over one second and updating the display every five seconds will mean that 80% of the measurements taken will never contribute to a displayed flow value. The flowmeter does not prohibit or warn against such inconsistent settings.

The units of measure for flow rate can be configured in **Setup Mode**. The units in which both volume and time are expressed can be selected from appropriate options. A custom unit of measure for volume can be selected by specifying the size of one U.S. Gallon in that unit.

You may wish to suppress the display of very small flow values. The you can configure a **Low Flow Cutoff** value so that if the flowmeter would display a value smaller than this, it displays zero instead. By symmetry, the user can configure a **High Flow Cutoff** value. If the flowmeter would display a value larger than this, it displays the cutoff value instead. Note that these values are entered in the **Setup Mode** as numbers and must be given in the units of measure configured for flow rate display. If at some later time you change the units of measure, the cutoff values will upon inspection appear to have changed, but will represent the same flow rate, just in different units of measure.

Should you observe that the flowmeter’s readings are consistently in error by a measurable amount, it is possible to correct this situation by configuring a **Scaling Offset**. The Factory Default for this is 1.00. The flowmeter will accept values from 0.00 to 9.99. Every measurement taken by the flowmeter is multiplied by this number before further processing. Flow rate and flow total will therefore be affected. The **Scaling Offset** is part of a **Configuration Set**, so it does not apply to the flowmeter as a whole and should be set as required in each numbered Set.

If flow measurement is restarted (by passing through the **Startup State**, for whatever reason), then all prior measurements previously stored for the purpose of averaging are discarded. A new average is computed using only new flow measurements and they begin to arrive after the restart. The display area in which the flow rate appears is blanked (made empty) until the first measurement is made and the first average is computed.

7.1.2 Total Flow Measurement

As well as averaging measurements to display flow rate, the flowmeter totals all measurements divided by the measurement period to compute a totalized flow. This is written to the display at the same configured intervals as for flow readings.

The units of measure for total flow can be configured independently of flow rate.

Pressing the **CLEAR** soft button zeros the total accumulated flow if this option has been enabled by the configuration.

Should the flowmeter experience a power loss or be restarted by entry into **Setup Mode**, it will preserve a recent value of the total flow and restore this when next entering **Run Mode**. In **Run Mode**, the Total Flow will be saved to non-volatile memory every ten seconds. Any fluid that flows while the flowmeter is not in **Run Mode** is not included in the total.

7.2 Measurement Status Areas

The top line of the **Run Mode** screen shows the status of the measurement process. On the far left is shown the active **Configuration Number**, active **Measurement Mode** and the **Transducer Separation Distance**. In the center is shown the **Goodness of Measurement** index. On the right is shown the **Speed of Sound** in the fluid (if in transit time mode).

7.2.1 Configuration and Mode

The field on the top left displays the active **Configuration Set**, the measurement method in effect (T for Transit Time or D for Doppler) and the transducer separation distance. The display shown to the right indicates: **1 T 2.46 in.**

- Configuration Set #1
- Transit Time measure method
- 2.46 inches separation distance.

The measurement method can be changed by the two-position switch on the controller motherboard (the wiring access door must be removed to get at this switch) whereupon the flowmeter will automatically enter Setup Mode.

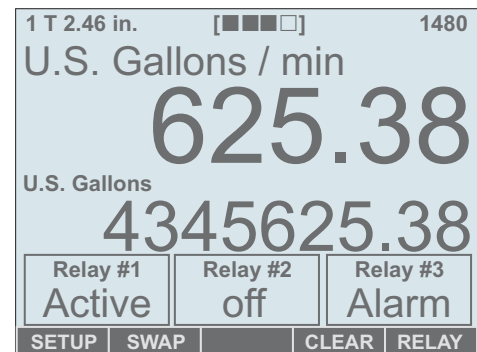

In Transit Time mode, the transducer separation distance shown is the distance used in **Transducer Positioning**, see section 2.8 above. In Doppler mode, this display value will always be zero. In both modes, the units of measure will be for the distance selected in the **Transducer Setup** menu, see section 5.4.2 above. If English (U.S. units) is selected, then the units displayed will be **in.** for inches. If Metric (SI units) is selected, then the units displayed will be **mm** for millimeters.

7.2.2 Goodness of Measurement

The field in the top center of the display status line displays the “Goodness of Measurement” which indicates the reliability of ultrasonic flow measurement under the present working conditions. This is computed by the algorithms that determine fluid velocity. The average of all samples computed during each display update interval is taken and then displayed as a reliability index of 0 to 4 bars. [■■■■] Zero bars indicate an unreliable measurement and four bars indicate high reliability.

The same goodness of measurement indication appears on the four amber LEDs on the controller motherboard, which can be viewed if the wiring access door is removed.

If flow measurement is restarted (by passing through the Startup State), then prior goodness of measurement information is discarded and the display will show zero until new information is computed.

Sonic-Pro**7.2.3
Sound Speed
Display**

The field on the top right displays either a speed of sound measurement value (if in Transit Time mode) or a zero (if in Doppler mode).

When operated in the transit time mode, the flowmeter periodically calculates the speed that sound is traveling through the fluid and displays the resulting value in meters per second. This value is useful for determining the reliability of the measurement and also for configuring the meter for unknown **Custom Fluids**. A list of the **Fluid Types** that are available for selection in the meter and their sound speed is shown in the index at the end of this manual. The displayed value should closely match the fluid's sound speed. Should the displayed value not match, one or more of the following conditions may exist:

- The transducers are not positioned correctly
- The pipe material type does not match the **Pipe Material Type** specified in the **Transducer Setup** configuration menu
- The pipe wall thickness is other than specified in the **Transducer Setup** configuration menu
- The fluid type does not match the **Fluid Type** specified in the **Transducer Setup** configuration menu
- The fluid's temperature is different than the temperature of the index values

See section 7.2.4 below for information on configuring the meter for unknown Custom Fluids.

**7.2.4
Measuring the
Fluid Sound
Speed**

The following outlines how to use the flowmeter to determine the speed of sound in a fluid. For the flowmeter to function, the precise speed of sound does not need to be known in advance. However, to place the transducers in the optimal location, knowing the speed of sound in the fluid is important. The following outlines a procedure that you can follow in determining the fluid speed of sound.

- This test can be performed with or without flow. It is recommended that the test be performed with zero flow.
 - The pipe outer diameter and wall thickness should be known precisely. It is recommended to use a small section of pipe so that the exact dimensions can be measured.
 - The speed of sound calculation is also affected by transducer placement. Any error in the spacing of the transducers will translate to an error in the calculated speed of sound.
- 1) Enter all the appropriate information for pipe material and dimensions.
 - 2) Select "custom" as the fluid type and enter a custom speed of sound for the fluid in meters/second. Use a best first guess – if it's a water based fluid, start with something close to the speed of sound for water. If it's an oil based fluid, use something close to the speed of sound for oil. See the index for sample fluid sound speeds.
 - 3) Save and activate your configuration. Place the transducers at the spacing specified by the meter. Press DONE. The meter will now calculate and display a speed of sound in the upper right hand corner. If the displayed speed of sound matches that which was entered, then that value should be used. If the displayed speed of sound is different, or a fault occurs, change the fluid speed of sound to the displayed value or try a new estimate and repeat step 3.

When estimating the sound speed, use a systematic approach by increasing or decreasing your estimate by a fixed value, such as 100 meters per second.

During the run mode, the displayed speed of sound should closely match the entered speed of sound (provided proper transducer placement and no change in temperature or properties of the fluid such as density).

7.3 Process Control Status Areas

If the flowmeter is fitted with the Process Control Board, three **Process Control Status Areas** appear on the display under the secondary display area and above the soft button labels. The Model S2, Model S3 and the User PC Software display is the same. Each area is labeled with the relay number to which it refers and shows the status of that relay channel. If a relay channel is disabled in configuration, the corresponding status area will be blank.

For channels configured to monitor flow total, the **Process Control Status Area** shows **IDLE**, **ACTIVE** or **PAUSE**, corresponding to the state of the channel. **ACTIVE** is displayed in white-on-black. For detailed information on the operation of relay channels monitoring total, see section 8.2 below.

For channels configured to monitor flow rate, the **Process Control Status Area** shows **ALARM** or **CLEAR**. **ALARM** is displayed in white-on-black and corresponds to the channel states **ALARMING**, **ALARMED** and **CLEARING** (that is, when the flow rate is outside the set limits or an alarm condition has been latched, whether the relay itself is energized or not). **CLEAR** is displayed in normal black-on-white and corresponds to the **CLEAR** state of the channel, when the flow is within the limits and no alarm is latched. For more information about channel states, see section 8.3 below.

7.4 Soft Buttons

In addition to the **SWAP** and **CLEAR** soft buttons, discussed above, two other soft buttons will be present under certain circumstances. Buttons that are not present appear blank.

The **SETUP** soft button will be present on Model S3 and also at a User PC Software connection if fitted. Pressing the **SETUP** soft button causes the flowmeter to enter **Setup Mode** and the **Setup Mode Screen** replaces the **Run Mode Screen**, see section 6 above for details. Operation of the flowmeter is immediately disrupted as flow measurement does not take place in **Setup Mode**.

The **RELAY** soft button will also be present if the conditions above for the **SETUP** soft button are met and the Process Control board is fitted but not if all relay channels are disabled in configuration. Pressing the **RELAY** soft button causes the **Process Control Screen** to replace the **Run Mode Screen**, see section 8.1 below for details. The flowmeter at first continues to operate normally, although the user can no longer see the information displayed on the **Run Mode Screen**, but some actions that the user can take on the **Process Control Screen** will disrupt measurement.

7.5 Output Signals

The flowmeter provides two output signals that represent the flow rate. An analog output represents the flow rate as a current amplitude. A digital pulse output represents the flow rate as a pulse frequency. These signals will have their values (current and frequency) changed to the same values and at the same period as the flow display. In other words, they are affected in the same way by the configured averaging time, display update period and cutoffs.

7.5.1 Analog Signal Output

The analog signal output has a current range of 4 to 20 mA. The correspondence of current to flow rate can be configured by specifying two (flow rate, current) points. Low and high flow rates, which must not be the same, are specified and the currents corresponding to each are given. Other flow rates are mapped to currents using a straight line through the points specified. The current for the high flow rate may be smaller than the current for the low flow rate, in which case the current will decrease with increasing flow rate. Flow rates mapping to currents outside the available range will cause the signal to saturate at the closest limit.

Sonic-Pro

7.5.2 Digital Pulse Output

The digital pulse output has a frequency range of 0 to 1000 Hz. The correspondence of pulse frequency to flow rate can be configured by specifying two (flow rate, frequency) points. Low and high flow rates, which must not be the same, are specified and the frequencies corresponding to each are given. Other flow rates are mapped to pulse frequencies using a straight line through the points specified. The frequency for the high flow rate may be smaller than the frequency for the low flow rate, in which case the frequency will decrease with increasing flow rate. Flow rates mapping to frequencies outside the available range will cause the signal to saturate at the closest limit.

7.6 Data Logging

The flowmeter is able to log flow data internally to a memory buffer and to a removable SD Card. If the Communication Board is fitted and connected to a PC running the Sonic-Pro software application, the internal buffer data will automatically download to the user's PC hard drive. The generation of a log entry can be triggered periodically, by the flow rate passing configurable setpoints and by the total flow passing configurable setpoints. All log entries are identical and do not indicate which of the forgoing mechanisms caused their generation. All log entries look like this:

```
2006/12/15 13:10:43 Rate: 2396.25 Total: 4345625.38 Code:
```

The date is ordered year/month/day. The time is military or European time, so no a.m./p.m. field is needed. The flow rate and total flow are recorded as they would appear on the display, units of measure are not included. Up to two error codes will be recorded if present.

The internal memory buffer can hold approximately 10,000 log entries. The 32 Mbyte SD card (included) will accommodate about 500,000 entries. At one entry per minute, it will fill up in a little less than a year. If the SD Card is not present, data logging still takes place but only buffered entries can be retrieved by a User PC Software application, see section 7.6.5 below.

7.6.1 Periodic Logging

The interval between periodic log entries can be configured from 1 to 999999 seconds. If this number is set to zero, periodic logging will not occur. Log entries can only be generated when flow information is produced for display.

7.6.2 Logging Rate Setpoints

Maximum and Minimum Flow Rate Setpoints can be configured in **Setup Mode** so that the flowmeter records the time at which the flow rate crosses these values. A log entry is generated when the flow rate crosses the **Maximum Flow Rate Setpoint** value while increasing. A log entry is also generated when the flow rate crosses the **Minimum Flow Rate Setpoint** value while decreasing. These log entries are not distinguished from other entries and consist, as always, of the timestamp, the flow rate immediately after the setpoint was crossed and also the total flow at that time.

When a log entry has been generated due to the crossing of a **Log Rate Setpoint**, as described here, no further log entries are generated due to the crossing of the same **Log Rate Setpoint** for a period of one minute. The intent is to suppress "flicker", i.e. many log entries due to the flow rate hovering around the setpoint and crossing it repeatedly.

Log Rate Setpoints must be specified in the units of measure configured for flow rate.

7.6.3 Logging Totalizer Setpoints

Five **Flow Total Setpoint** values can be configured in **Setup Mode** so that the flowmeter records the time at which the total flow crosses each of these values. When this occurs, a single log entry is generated. It is not distinguished from other entries and consists, as always, of the timestamp, flow rate and the actual total flow value that exceeded the setpoint. **Flow Total Setpoint** values do not have to be in ascending order. They must be specified in the units of measure configured for flow total.

7.6.4 Local Log Data Storage (SD Data Card Storage)

Log entries will be written to the flowmeter's Flash memory card if one is installed. The flowmeter supports Secure Digital (SD) and MultiMediaCard (MMC) flash memory cards of most common brands and capacities. If a correctly formatted card is not installed appropriately (see below), log entries will not be written but in all other respects the flowmeter will operate normally. The flowmeter is shipped with a 32MB card installed.

7.6.4.1 Inserting and Removing the Memory Card

To insert or remove a memory card, it is necessary to open the wiring access door of the flowmeter. The card slot is on the bottom of the main PCB, and therefore hard to see, but its position is marked on the top silkscreen. To insert a card, hold it with the label side away from, slide the end with the gold contacts under the PCB into the slot and push gently until it clicks into place. To remove a card, push it inwards until it clicks again and then release the pressure. A spring will push it out slightly. From this position, slide the card fully out.

The first time a memory card is installed, the meter must be power cycled while the card is in place. After the initial installation, the memory card should only be inserted or removed when the flowmeter is in the **Setup Mode** or if the meter is powered off. Before inserting or removing the card, use any of the methods described in section 4 above to enter **Setup Mode**. Flow measurement will be disrupted. After inserting or removing the card, the flowmeter can be returned to **Startup** and then to **Run Mode**, see section 4.3 above for details. If a card is inserted when the flowmeter is not in **Setup Mode** or powered off, no harm will be done but log entries will not be written to it. To remedy this situation, enter and then leave **Setup Mode**. If the card is removed when the flowmeter is not in **Setup Mode**, data on the card may be corrupt. After retrieving undamaged log files, the card should be reformatted. Additionally, the flowmeter should be power-cycled.

7.6.4.2 Format of Data on the Memory Card

SD/MMC cards for use in the flowmeter should be formatted according to the FAT32 standard. Files can then be written to and read from the card by any computer that understands this file system (when fitted with the appropriate adapter) including PCs running Windows™ or Linux™.

Log entries are stored in files with names of the format `lognnnnn.txt`, where `nnnnn` is a decimal number from 00000 to 99999. Each log entry is written to a separate line in the file and is terminated with the newline character. Some older Windows-based text editors may not recognize newline as a line break (without a carriage return following it), but most modern software is compatible with this format. Log files are placed in the sub directory `logs` of the root directory of the memory card. Any files on the memory card that are not in the `logs` sub-directory or do not have names in the above format will be ignored by the flowmeter. Although they will reduce the space available for log files, they will not be deleted. Any files in the `logs` sub-directory with names that do look like log file names are at risk of being deleted to free up space on the card.

7.6.4.3 Rotation and Purging of Log Files

The log file currently in use is closed and a new one is opened in these situations:

- The flowmeter enters Setup Mode and then subsequently passes to Run Mode
- The log file reaches a size of approximately 1 MB (about 16,000 entries)

The five-digit number in the names of log files progresses by one each time this happens, so it is trivial to reconstruct the sequence of log entries over different files. In this sequence, 00000 follows 99999.

If the memory card has less than 1 MB of free space when a new file is opened, the oldest log files are deleted until this much free space exists. Thus, if log files are not moved off of the card before it fills up, new entries are preserved at the expense of old entries.

7.6.4.3 Rotation and Purging of Log Files (continued)

The five-digit numbers of the next log file and the oldest log file on the card are held in a file in the logs sub-directory with the name `logindex.txt`. If this file does not exist, the flowmeter will create it and start both numbers at 00001. Thus, the first log file will be `log00001.txt` and as further files (`log00002.txt` etc.) are created and filled the flowmeter will remember that `log00001.txt` is the oldest. If the space on the card is reduced below 1 MB, then `log00001.txt` will be deleted. The next file to be deleted to make space will be `log00002.txt` and so on.

When reading a card that has been removed from a flowmeter, care should be taken when deleting files before re-inserting it into the same or a different flowmeter. It is safe to delete all files on the card, in which case new log files will start with `log00001.txt` as described above. It is also safe to delete any or all log files if the file `logindex.txt` is left on the card. If the flowmeter tries to delete a file that does not exist, it will simply keep increasing the five-digit number in the filename until it finds enough files to delete that free up the space it is looking for. **However, if the `logindex.txt` file is deleted but log files are left on the card, the flowmeter may overwrite them if and when it counts up again to their numbers.**

7.6.4.4 Power Loss

In the event of a power loss, the flowmeter will not be able to properly close the open log file and it may as a result be corrupt. When power is restored and the flowmeter resumes operation, it will open a new log file with the next sequential number. Should the power loss have occurred when the flowmeter was updating file system management information on the memory card, it may not be able to mount the card when power resumes. In this case, no further log entries will be written to the card. As a result, care should be taken that the flowmeter is placed in **Setup Mode** before disconnecting it from a power source.

7.6.5 Remote Access to Log Data

A user PC that is running the **Sonic-Pro Software** and that is connected via the Communications Board will automatically acquire and store log entries from the flowmeter.

The flowmeter records in a buffer the most recently generated 10,000 log entries. If the buffer fills, entries are replaced in a first-in, first-out manner. At ten second intervals, the PC will request that the flowmeter send to it the latest 100 available entries, also in a first-in, first-out manner, until all entries are downloaded. The entries sent are removed from the flowmeter buffer and transferred to a file folder that the **Sonic-Pro Software Application** will create and place on the C: drive. Since all meters must have a unique IP Address to connect to the user PC Software, the Software will automatically use the IP Address as the name of this file folder.

Simply by making this request every ten seconds, the PC obtains a complete record of the data being logged in the flowmeter. There is no configuration item to turn on or off remote logging or to set up what is logged differently from internal logging to the SD card. The flowmeter is passive other than buffering and supplying on request its recent log entries. The user PC can do whatever it sees fit with the log entries, including, but not limited to, displaying them graphically, saving them to disk, comparing them to information from other flowmeters, etc. *Remote logging is not influenced by the presence or absence of the SD Card.*

To facilitate faster downloading, a button on the user PC software application may be pressed to immediately begin downloading all available logs in the buffer.

8.0 Process Control

Process Control functions are configured from the **Setup Mode** as described in section 5.4.4 above. In addition, you can interact with **Process Control** functions in **Run Mode** using **Process Control Screens** for each of the three relay channels. On these screens, you can inspect alarm status, clear alarms, dispense fluid batches, etc. Use of the **Setup Mode** has been discussed above. This section covers the use of the **Process Control Screens**.

To access **Process Control Screens** from the **Run Mode Screen**, press the **RELAY** soft button. This button does not appear (the soft button label is blank) if the Process Control option is not fitted to the flowmeter. None of the functions discussed in this section are available without the **Process Control option**. Additionally, either the Model S3 display option or the Communications Board and a connected **User PC Software Application** are necessary to perform the operations described. You must have at least one of these if they have a **Process Control Board**, otherwise it will be useless.



8.1 Process Control Screen

In **Run Mode**, **Process Control** functions are accessible in from the **Process Control Screens**. Pressing the **RELAY** soft button moves in a circular fashion from relay to relay and then back to the **Run Mode Screen**. Only those relay channels are visited that are configured to monitor Rate or Total in the active configuration. Relay channels that are disabled are skipped. If all relays are disabled, the **RELAY** soft button does not appear on the **Run Mode Screen**. This soft button is in the same location on the **Run Mode Screen** and the **Process Control Screens**.

The **Process Control Screen** displays:

- the selected relay number and whether the relay channel is monitoring Rate or Total
- if monitoring Rate, the current Flow Rate as it would appear on the Run Mode screen
- either the alarm trigger, release and delay time settings, if it is monitoring Flow Rate
- or the batch settings, count and totals, if it is monitoring Flow Total
- the state of the relay channel (described below)

For relay channels monitoring Flow Rate, a **CLEAR** soft button allows you to de-activate a relay that has been energized due to the rate reaching the trigger settings (see section 8.3.2 below for details).

For relay channels monitoring Flow Total, a **START** soft button allows you to start the dispensing of a batch (see section 8.2.1 below for details). Also for channels configured for Flow Total,  and  soft buttons allow you to select certain of the settings and status values. According to which is selected, a **CLEAR** or **EDIT** soft button appears.

Pressing the **CLEAR** soft button zeros the selected total. Pressing the **EDIT** soft button allows the **Batch Amount** to be changed. (See section 8.2 below for details and restrictions.) When the **Process Control Screens** are displayed, the flowmeter continues to operate normally in **Run Mode**. Flow is measured and totalized and all logging, monitoring and output signal functions continue uninterrupted. The **SETUP** soft button is not available. To leave **Run Mode**, first return to the **Run Mode Screen** using the **RELAY** soft button.

Sonic-Pro

8.2 Batch Dispensing

When a process control relay channel is configured to monitor Flow Total, it can be used to dispense fluid in batches. A **Process Control Screen** for a channel configured in this way is shown at right. The **RELAY** soft button is used to visit each channel in turn and go back to the **Run Mode** screen. The **START** soft button is used to initiate a batch. The left-most three soft button may be used to change the **Batch Amount** or clear the batch counter and the volume totals.



8.2.1 Manual Batch Start Type

If the **Batch Start** type is configured as **MANUAL**, then operation is as follows:



- Press the **START** soft button to begin the dispensing of a batch.
- The **START** soft button is replaced by the **STOP** soft button.
- The **Total this Batch:** value clears to zero.
- The **Current Batch #:** value increases by one.
- The relay is energized and the display changes accordingly.
- As the flowmeter measures and totals up fluid flow, the **Total this Batch:** and **Total all Batches:** values advance.
- When the **Total this Batch:** value reaches the **Batch Amount:** value, the relay is de-energized and the display changes accordingly.
- The **STOP** soft button disappears and the **START** soft button returns.

A batch can be interrupted and resumed as follows:

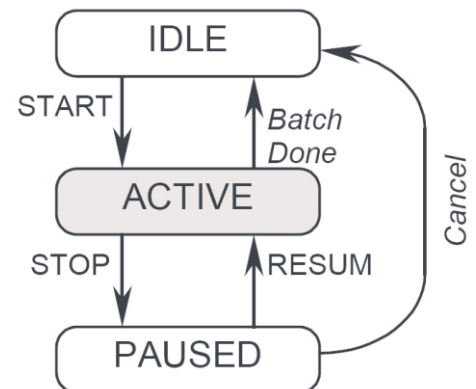
- Press the **STOP** soft button. The relay is de-energized and the **RESUM** (resume) soft button appears in place of this soft button.
- Although the display changes to show that the relay is de-energized, it alternates between black-on white and white-on-black to indicate that a batch has been interrupted.
- The flowmeter is still measuring flow, although the intent is clearly for the flow to stop, and the operation of all status displays continues.
- Press the **RESUM** soft button. The relay is energized again, the **STOP** soft button reappears and everything is as it was before the interruption.



A batch can be canceled (aborted) as follows:

- Interrupt the batch as described above.
- While the batch is stopped (the relay is de-energized), use the  or  soft buttons to navigate to and highlight the **Total this Batch:** status line. The **CLEAR** soft button replaces the RESUM soft button.
- Press the **CLEAR** soft button.
- The value of **Total this Batch:** is cleared to zero.
- All lines are de-selected and the **START** soft button returns.
- When the **START** soft button is next pressed, the next batch will dispense and the **Current Batch #:** value increases by one. *The cancelled batch is not re-dispensed.* The flow measured before it was cancelled is not backed out of **Total all Batches:**.

Because flow information is only computed by the flowmeter at the configured display update interval, the volume dispensed in a batch will typically overshoot the configured Batch Amount. The relay is de-energized when the measured total equals or exceeds the batch volume. The degree of overshoot depends on the batch size, the flow rate and the update interval. You should not configure long update intervals when dispensing small batches from a high flow rate, as in this situation the overshoot could be a significant fraction of the batch size.

8.2.2 Auto Batch Start Type

If the **Batch Start** type is configured as **AUTO**, then operation is as follows:

Immediately upon entering **Run Mode**, the flowmeter accumulates the volume of fluid flowing in two totalizers associated with the specific **Relay Channel**. If the relay channel is brought onto the display (using the **RELAY** soft button), the totals are displayed to the right of the labels **Total this Batch:** and **Total all Batches:** and the values will be seen to advance. *However, the channel will operate in the manner described here whether it is on the display or not.*

- The relay channel **Status:** is indicated as **ACTIVE**.
- When the **Total this Batch:** value reaches the **Batch Amount:** value, the **Current Batch #:** value increases by one, the **Total this Batch:** value clears to zero and the relay is energized. Flow is expected to continue (in this mode, flow is not controlled by the relay), so **Total this Batch:** immediately starts increasing again and **Total all Batches:** continues to increase without a break.
- After the relay has been energized for the number of seconds shown in the **Relay Timer:** field, it de-energizes (again, this is not expected to influence the fluid flow).

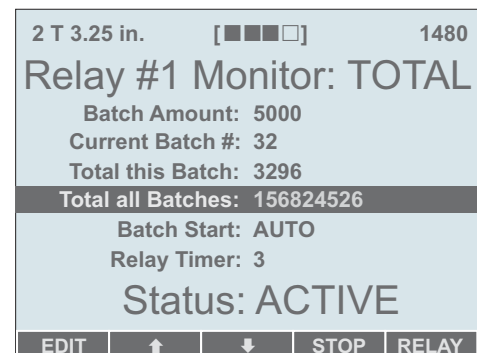

This continues indefinitely (unless the **STOP** soft button is pressed). Each time the **Total this Batch:** totalizer reaches **Batch Amount:**, it is cleared, **Current Batch #:** advances and the relay is energized for the time **Relay Timer:**.

In this mode of **Process Control**, the flowmeter is partitioning the flow in the pipe into batches of a defined amount. Within each batch, it displays the total flow so far for that batch. It counts the batches. At the end of each batch, the relay energizes for a defined time period and then de-energizes. An example of what the energized relay might do is to switch power to a pump or open a valve that results in some other fluid being injected into the measured fluid stream.

Ensure that the flow rate, batch amount and relay timer are set up so that the relay will de-energize before the end of each batch. Should the relay still be energized when the end of a batch is detected, then the time at which the relay will de-energize will be extended to the **Relay Timer** time from the new batch ending. If this repeats, the relay could remain continuously energized.

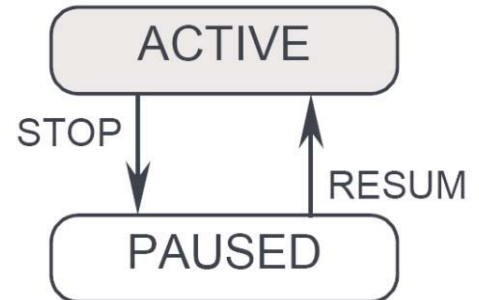

If the **STOP** soft button is pressed:

- The relay channel Status: is indicated as **PAUSED**.
- If the relay is energized, it will immediately de-energize.
- The **RESUM** (resume) soft button appears, replacing the **STOP** soft button.
- The flowmeter will no longer advance **Total this Batch:** nor energize the relay and increment **Current Batch #:** as batches of fluid pass by in the pipe.
- **Total all Batches:** continues to advance if there is flow in the pipe.





If the **RESUM** soft button is pressed:

- The relay channel Status: returns to **ACTIVE**.
- The **RESUM** soft button is replaced by the **STOP** soft button.
- The **Total this Batch:** value clears to zero.
- The **Current Batch #:** value increases by one, indicating a new batch in progress.
- Operation is as before **STOP** was pressed (**Total this Batch:** advances and, at the end of each batch, clears, energizing the relay for a specified time and advancing **Current Batch #:**).

To start counting batches from zero again or clear the value of **Total all Batches:**, use the  and  and **CLEAR** soft buttons.

8.2.3 Batch Clear

The **Current Batch #**, **Total this Batch** and **Total all Batches** values can be cleared. To do this, press the  and  soft buttons until the desired value is highlighted. The **CLEAR** soft button then appears in the left-most position. Pressing this soft button zeros the value.

The clearing of counts and totals can be blocked by configuring the **Total Display Function** to **Clear Total Disabled**. If this is done, the **CLEAR** soft button does not appear. Note that this configuration item is in the **Metering Setup** branch, but even so affects **Process Control** functions.

8.2.4 Batch Edit

If the relay channel is configured for **Batch Start** type **MANUAL**, the **Batch Amount:** value can be changed. To do this, press the  and  soft buttons until the present value is highlighted. The **EDIT** soft button then appears in the left-most position. Pressing this soft button allows the value to be edited.

It is not possible to change the **Batch Start:** type or the **Relay Timer:** value. It is also not possible to change the **Batch Amount:** value if the **Batch Start** type is **AUTO**.

8.3 Flow Rate Alarms

When a process control relay channel is configured to monitor Flow Rate, it can be used to indicate that the rate of fluid flow has reached or passed configured trigger values. A Process Control Screen for a channel configured in this way is shown at right. The **RELAY** soft button is used to visit each relay channel in turn and go back to the Run Mode screen. The **CLEAR** soft button can be used to clear an alarm condition while the problem causing the alarm is being rectified.

8.3.1 Basic operation

Operation of Flow Rate Alarms will be described with reference to the state diagram below.

The relay channel starts in the **CLEAR** state. It will remain in this state so long as the displayed flow rate remains *both* less than the **High Trigger** value and greater than the **Low Trigger** value. Note that the displayed flow rate is subject to the configured averaging, high and low flow cutoff and any scaling offset value.

If the flow rate rises to or above the **High Trigger** value or falls to or below the **Low Trigger** value, then the relay channel changes to the **ALARMING** state (arrow a in the diagram at right). If the **Alarm Delay Time** has not been configured or it has been configured to zero, the relay channel immediately changes to the **ALARMED** state (arrow b). Otherwise, it remains in the **ALARMING** state while the **Alarm Delay Time** is counted down. In this state, the relay is not energized. The status displays as Status: **ALARMING** in alternating black-on white and white-on-black and the **CLEAR** soft button is present. If the **CLEAR** soft button is pressed, counting down the **Alarm Delay Time** restarts. This state gives an operator time to correct the condition causing the alarm or for the condition to correct itself if it is transient.

When the **Alarm Delay Time** expires in the **ALARMING** state (which may be immediate, see above) the relay channel changes to the **ALARMED** state (arrow b). The relay is energized. The status displays as Status: **ALARMED** in white-on-black. The **CLEAR** soft button is present. If the **CLEAR** soft button is pressed in the **ALARMED** state and a non-zero **Alarm Delay Time** is configured, the relay channel changes to the **CLEARING** state (arrow c). The relay is now de-energized. The status displays as Status: **CLEARING** in white-on-black and the **CLEAR** soft button is not present. The purpose of this state is similar to the **ALARMING** state, but it is available after the alarm has occurred if the operator did not act early enough. The flowmeter counts down the **Alarm Delay Time**. If this time expires and the condition causing the alarm has not been removed (arrow e, see below), the relay channel returns to the **ALARMED** state (arrow d). If the **CLEAR** soft button is pressed in the **ALARMED** state but **Alarm Delay Time** is zero or has not been configured, then nothing will happen unless a **Release value** has not been configured and the flow rate has returned to normal (more on this below). In this case, the relay channel changes to the **CLEAR** state (arrow e).

In the **ALARMING**, **ALARMED** and **CLEARING** states, the relay channel may change to the **CLEAR** state (arrow e) without user action if a **Release value** has been configured for the **Trigger** value that has been passed to cause the alarm and the flow changes to be equal to or inside that release value. For example, if the alarm occurred because the flow rose above the **High Trigger** value and a **High Release** value has

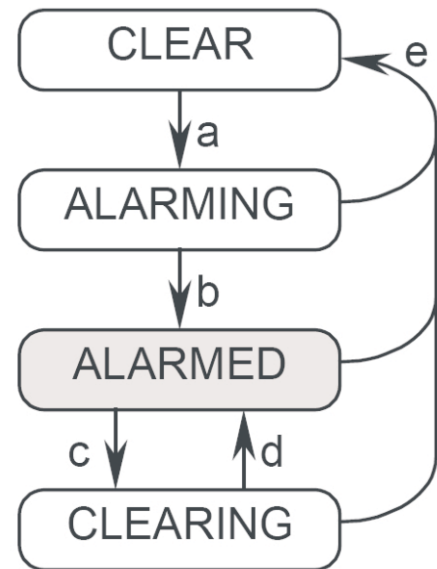

been configured, then at any time the flow falls to or below that value the alarm is automatically cleared and the relay channel returns to the **CLEAR** state. (This is what the operator is going to be striving for in the **ALARMING** and **CLEARING** states.) If a **Release** value has not been configured for the **Trigger** value that caused the alarm, then the relay channel will only follow arrow e back to the **CLEAR** state if the flow falls back inside the **Trigger** value and the operator presses the **CLEAR** soft button (as first stated above). A **Release** value that is identical to its corresponding **Trigger** value has the same effect as if it were not configured (it prevents automatic recovery from that direction).

The **Alarm Delay Time** cannot be configured to a value greater than 3600 (one hour). If the **Alarm Delay Time** is configured to zero, it is effectively disabled and displays as **NONE**.

Any **Trigger** or **Release** value that is set to zero is effectively disabled and displays as **NONE**. This includes the **Low Trigger**, so if the user wishes to alarm on zero flow, he must set the **Low Trigger** to a very small, but non-zero, flow value. Disabling a **Trigger** value causes the corresponding release value to be also disabled. If a **Release** value is disabled, or set to the same value as the corresponding **Trigger**, then the flowmeter will not automatically release an alarm caused by that trigger (the **CLEAR** soft button must be pressed to release the alarm).

8.3.2 Clearing Alarms

The **CLEAR** soft button appears on the screen in the **ALARMING** state and also in the **ALARMED** state if an **Alarm Delay Time** has been set or if no **Release** value has been set for the **Trigger** that caused the alarm.

If the **CLEAR** soft button is pressed when in the **ALARMING** state, the countdown of the **Alarm Delay Time** will re-start, providing extra time to correct the problem.

If the **CLEAR** soft button is pressed when in the **ALARMED** state and when an **Alarm Delay Time** has been set, then the relay will de-activate, the **Status:** display will read **CLEARING** in white-on-black and the **CLEAR** soft button will disappear. The intent is that the operator now goes and fixes whatever caused the flow to go out of bounds. If the flow falls within the **Release** limits before the alarm delay time expires, then the **Status:** display will read **CLEAR** and the relay will remain de-activated. If the number of seconds set in the **Alarm Delay Time:** field passes after the **CLEAR** soft button is pressed and the flow rate is still outside of the **Release** limits, then the relay re-activates, the **Status:** display will read **ALARMED** and everything will be as it was before the soft button was pressed.

If the **CLEAR** soft button is pressed when in the **ALARMED** state and when no **Alarm Delay Time** has been set and no **Release** value has been set for the **Trigger** that caused the alarm, then what happens depends on whether the flow has fallen back inside the **Trigger** value. If it has, the alarm will be cleared. If it hasn't then nothing will happen.

8.3.3 Editing Alarms

None of the settings of a relay channel configured to monitor Flow Rate can be changed from the Process Control screen. The  ,  and **EDIT** soft buttons do not appear.

8.3.4 More on Alarm Conditions

This section contains additional explanation of the conditions under which an alarm condition is cleared.

The flowmeter will clear an alarm condition automatically if and only if a **Release** value has been set for the **Trigger** value that caused the alarm. For example, if the alarm was caused by the flow rate falling below the **Low Trigger**, then the alarm will be automatically cleared if a **Low Release** has been set. Whether or not a **High Release** is set in this case is of no consequence. If a **Release** value has not been set, the alarm is said to be “latched”. A latched alarm can only be cleared if the user presses the **CLEAR** soft button and the flow rate has fallen back inside the **Trigger** values.

The effect of setting an **Alarm Delay Time** is to add states in which an alarm condition exists but the relay is temporarily not energized. During these states, the alarm condition may clear and the relay will then remain de-energized. These states end when the **Alarm Delay Time** elapses and if at that time the alarm condition has not cleared then the relay will energize.

The four combinations of a set **Release** value (for the alarming Trigger value) and an **Alarm Delay Time** are as follows:

- **No Release** value, **no Alarm Delay Time** - the alarm is latched and can only be cleared by the user pressing the **CLEAR** soft button when the flow rate has fallen inside the **Trigger** value.
- **Release** value, but **no Alarm Delay Time** - alarm clears automatically as soon as the flow rate falls inside the **Trigger** value (the **CLEAR** soft button serves no purpose).
- **No Release** value, an **Alarm Delay Time** is set - the alarm is latched (will never clear automatically) and must be cleared by the user pressing the **CLEAR** soft button, however, as well as clearing on the press if the flow is inside the **Trigger** value, it will also clear if the flow falls inside the **Trigger** value while the **Alarm Delay Time** is being counted down (the channel is in the **CLEARING** state).
- **Release** value and an **Alarm Delay Time** - the alarm clears whenever the flow rate falls inside the **Trigger** value and the purpose of the **CLEAR** soft button is only to temporarily de-energize the relay.

9.0 Sonic-Pro User PC Software

This section describes the Sonic-Pro User PC Software application.

Any Sonic-Pro model can be equipped with a **Communications Package** that includes circuitry, connector panel and custom Sonic-Pro User PC Software. When connected to a computer running the Sonic-Pro software, any model can perform the **Model S3** functions described in this manual including program editing and data logging downloads directly into the PC.

The Sonic-Pro Software user interface mimics the S3 model 5-button touch pad so learning to use the software application is simple. Simply clicking on the buttons is the same as pressing the buttons on the Sonic-Pro SPU touch pad. Pressing and holding shift while clicking on a button simulates pressing and holding a button on the touch pad.

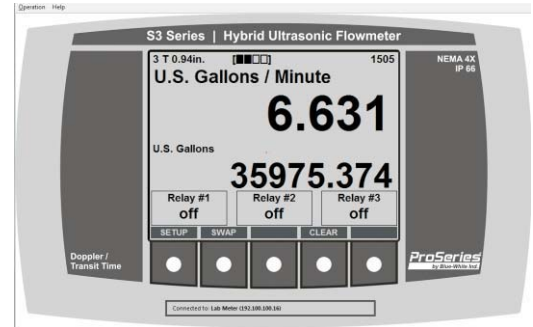

9.1 Software Installation

The Sonic-Pro Software installation files are located on the CD that was shipped in the Sonic-Pro. Open the CD and double click SETUP. Follow the instructions to install the Sonic-Pro software onto your PC.

9.2 Making connections

When opening the software, a connection type must be selected. Chose ETHERNET, RS-232 or USB.

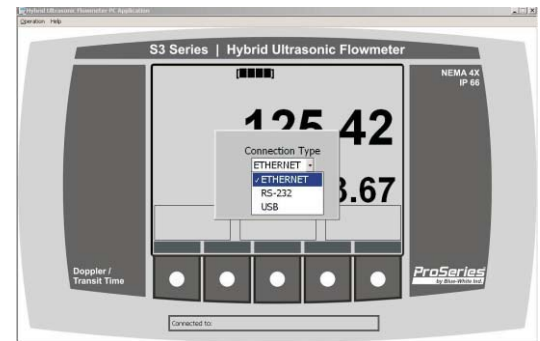

9.2.1 Ethernet Connection

If connecting via ETHERNET, select a meter from the pull-down menu and press DONE to activate the selected meter. If the display does not activate or if some of the data is not displayed, disconnect the meter by clicking on OPERATION in the upper left corner pull down menu and click DISCONNECT. Re-select the meter and press DONE.

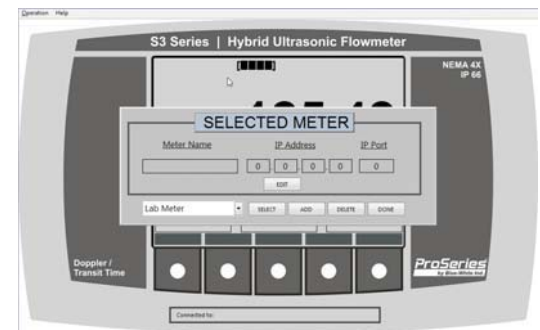

To ADD a new meter to the pull-down menu, press ADD, input a name for the new meter, input the meter IP ADDRESS and IP PORT number (usually 26000). Press SAVE EDITS. The IP ADDRESS must match the IP address configured in the meter SPU. See section 5.2.1 of this manual. If the meter is installed on a network, the IP address must be an address that is available to the network. Contact your IT department for assistance with network configurations. The new meter can now be selected and activated.

An unlimited number of meters may be added to the pull-down menu but only one meter at a time may be selected.

9.2.2 Serial & USB Connection

If connecting via RS-232, you must select a SERIAL COM PORT number.

If connecting via USB, you must select also select a COM PORT number. This is because the USB connection utilizes a USB/SERIAL conversion method.

First connect the USB cable to the SPU. Once connected, the new COM PORT number should automatically appear in the pull-down menu and can now be selected. (It will most likely be the largest number port shown.)

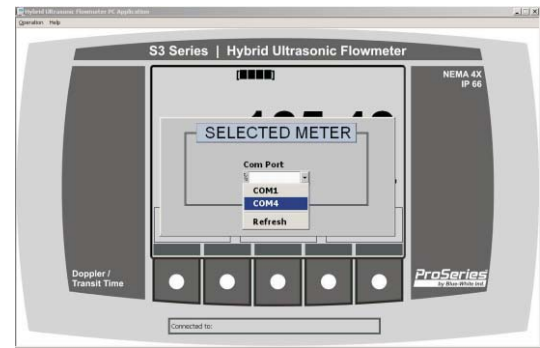

NOTE: On some computers, an adjustment will be need to be made to the “latency timer” setting on the USB COM port to enable proper communications. Go to **Control Panel / Systems and maintenance / Device Manager**. Select **PORTS**. Double click **USB CONVERTER**. Select the **PORT SETTINGS** tab. Click **ADVANCED**. Set **LATENCY TIMER** to a value of 1. Save the settings.

9.3 Retrieving Log Data

When the Sonic-Pro software is connected to the SPU and activated, ALL log data that is stored in the SPU buffer is automatically downloaded to a folder named “Ultrasonic Flowmeter” and placed on the computer’s C: drive. Log data is stored in a .TXT file.

The Sonic-Pro SPU can store approximately 10,000 logs. New logs will replace old logs on a first in - first out protocol.

Each individual log file consists of Date, Time, Flow Rate value, and Flow Total value.

```
2008/07/15 07:18:27 Rate: 3.241483 Total: 147.137275 Code:
```

Note that log files stored on the SD memory card are not affected by the SPU buffer.

```

File Edit Format View Help
2008/07/14 08:57:11 Rate: 7.919867 Total: 531.231155
2008/07/14 08:57:12 Rate: 4.056041 Total: 531.231155
2008/07/14 08:59:32 Rate: 2.328023 Total: 537.329024
2008/07/14 09:01:43 Rate: 3.114527 Total: 539.834220
2008/07/14 09:03:11 Rate: 4.732967 Total: 549.346332
2008/07/14 09:06:16 Rate: 0.000000 Total: 556.489091
2008/07/14 09:06:58 Rate: 2.174051 Total: 556.629119
2008/07/14 09:09:16 Rate: 0.000000 Total: 561.188553
2008/07/14 09:10:39 Rate: 4.823868 Total: 561.617298
2008/07/14 09:12:26 Rate: 2.117735 Total: 569.812112
2008/07/14 09:13:27 Rate: 2.632968 Total: 573.601243
2008/07/14 10:40:37 Rate: 2.451821 Total: 660.073079
2008/07/14 10:41:35 Rate: 0.000000 Total: 661.815029
2008/07/14 10:43:17 Rate: 2.048129 Total: 661.849464
2008/07/14 10:45:01 Rate: 8.703473 Total: 665.367710
2008/07/14 10:45:02 Rate: 4.462211 Total: 665.367710
2008/07/14 10:46:36 Rate: 24.765359 Total: 665.780178
2008/07/14 10:48:01 Rate: 0.000000 Total: 671.392577
2008/07/14 10:49:35 Rate: 2.061134 Total: 671.518706
2008/07/14 10:50:54 Rate: 2.056518 Total: 674.832470
2008/07/14 10:51:01 Rate: 2.957882 Total: 675.194561
2008/07/14 10:52:08 Rate: 2.480391 Total: 682.563793
2008/07/14 10:53:15 Rate: 2.345490 Total: 684.661232
2008/07/14 10:58:33 Rate: 2.454410 Total: 688.593680
2008/07/14 11:00:01 Rate: 0.000000 Total: 690.360502
2008/07/14 11:03:01 Rate: 0.000000 Total: 690.360502
2008/07/14 11:06:21 Rate: 0.000000 Total: 690.360502
2008/07/14 11:08:54 Rate: 2.508925 Total: 693.452778
2008/07/14 11:09:21 Rate: 4.853064 Total: 694.750689
2008/07/14 11:33:27 Rate: 2.038149 Total: 741.789530
2008/07/14 11:34:02 Rate: 0.000000 Total: 741.942235
2008/07/14 11:37:02 Rate: 0.000000 Total: 741.942235
2008/07/14 11:38:57 Rate: 10.928541 Total: 750.256056
2008/07/14 11:40:02 Rate: 0.000000 Total: 751.780661

```

10.0 Indexes

10.1 Complete Flowmeter Model Number System

Sonic-Pro Ordering Information		IPS Pipe Size	Pipe Pressure Rating
Sonic-Pro Part Number Matrix		020 2"	SK Sch 5 (ASTM D 1785)
Base Electronics Package		025 2-1/2"	SA Sch 10 (ASTM D 1785)
S1	Factory configured without display ¹	030 3"	SB Sch 20 (ASTM D 1785)
S2	Factory configured with display ¹	040 4"	SC Sch 30 (ASTM D 1785)
S3	Factory configured with user configurable display	050 5"	SD Sch 40 (ASTM D 1785)
Smart Communications and Control ²		060 6"	SE Sch 60 (ASTM D 1785)
A	Communications Includes Ethernet, USB, RS-232, RS-485 connections, and user configuration and monitoring PC software.	080 8"	SF Sch 80 (ASTM D 1785)
B	Process control Includes three 10 amp, form C relays. Note: Requires S3 configurable display or the communications option	100 10"	SG Sch 100 (ASTM D 1785)
C	Both Communication and Process Control options	120 12"	SH Sch 120 (ASTM D 1785)
X	None	141 14"	SI Sch 140 (ASTM D 1785)
Power Supply Cord Rating and Plug Type ⁵		161 16"	SJ Sch 160 (ASTM D 1785)
1	U.S. 125V with NEMA 5/15 plug	181 18"	DA SDR 41 (ASTM D 2241)
2	European 250V with CEE 7/VI plug	201 20"	DB SDR 26 (ASTM D 2241)
3	U.S. 250V with NEMA 6/15 plug	220 22"	DC SDR 21 (ASTM D 2241)
X	Power cord without attachment plug	240 24"	PA PN 4 Metric (DIN 8062)
Transducer Model and Cable Length		260 26"	PB PN 6 Metric (DIN 8062)
A1	Model A with 10 ft cable	281 28"	PC PN 10 Metric (DIN 8062)
A2	Model A with 25 ft cable	300 30"	PD PN 16 Metric (DIN 8062)
A3	Model A with 50 ft cable	320 32"	PE PN 20 Metric (DIN 8062)
A4	Model A with 100 ft cable	340 34"	BB CLASS B British (BS 3506)
Nominal Pipe Size ⁴		360 36"	BC CLASS C British (BS 3506)
Select from options list		420 42"	BD CLASS D British (BS 3506)
Pipe Pressure Rating ⁴		480 48"	BE CLASS E British (BS 3506)
Select from options list			B7 CLASS 7 British (BS 3506)
Pipe Material ⁴			TA Sanitary Tubing 0.065" wall
Select from options list			TB Sanitary Tubing 0.083" wall
Display Volume Units ³		Metric Pipe Size	TK Type K copper (ASTM B 88)
G	Gallons	063 63mm	TL Type L copper (ASTM B 88)
L	Liters	075 75mm	TM Type M copper (ASTM B 88)
F	Cubic Feet	090 90mm	XX User configured
A	Acre Feet	110 110mm	
M	Cubic Meters	125 125mm	
Display Time Units		140 140mm	
M	Minutes	160 160mm	
H	Hours	180 180mm	
D	Days	200 200mm	
Fluid ⁴		225 225mm	
Select from options list		250 250mm	
Display language		280 280mm	
E	English	315 315mm	
S	Spanish	355 355mm	
G	German	400 400mm	
F	French	450 450mm	
Sample model number		500 500mm	
S3	C	560 560mm	
1	A1	630 630mm	
060	SD	710 710mm	
J	G	800 800mm	
M	AL	101 1000mm	
AL	E	XXX User config.	

10.2 Additional Transducers Model Number System

Transducer Set Only	
ST	SonicPro Transducer
Pipe Size	
A	A model standard transducers
Cable Length	
010	10 feet
025	25 feet
050	50 feet
100	100 feet
Sample model	
ST	- A - 010

Fluid	
AA	Alcohol (Ethyl alcohol; Ethanol)
AB	Benzene
AC	Ethylene glycol
AD	Ethylene glycol / water (50%)
AE	Gasoline
AF	Isopropyl alcohol
AG	Methyl alcohol (Methanol)
AH	Methyl ethyl Ketone
AI	Milk, homogenized
AJ	Oil, diesel
AK	Toluene
AL	Water (distilled; waste)
AN	Water, sea
AP	Wine
XX	User configured

10.3 Specifications

General Operation

Measuring Principle

Hybrid. User-selectable Doppler or Transit Time operating modes.

Fluid Types

Virtually any acoustically conductive fluid.

Transit time mode operation from 0% to 10% (0 to 100,000 ppm) particulate.

Doppler mode operation from 0.02% to 15% (200 to 150,000 ppm) of 50 micron particulate.

Fluid Velocity Range

0.25 to 30 feet per second (0 to 9 meters per second)

Nominal Pipe Sizes

Doppler mode: 1.0 inch - 100 inch (63mm to 2500mm)

Transit time mode: 1.5 inch - 100 inch (63mm to 2500mm)

Pipe Materials

Most metal and plastic pipes

Pipe Liner Materials

Most plastic and concrete liners

Pipe Material	Pipe Size Ranges	Max Pipe Wall
Brass (Naval)	2" to 100" (63mm to 2500mm)	.500" (13mm)
Copper	2" to 100" (63mm to 2500mm)	.500" (13mm)
FRP (fiberglass Reinforced Plastic)	2" to 100" (63mm to 2500mm)	.500" (13mm)
Iron (cast)	2" to 100" (63mm to 2500mm)	.500" (13mm)
Iron (ductile)	2" to 100" (63mm to 2500mm)	.500" (13mm)
Nylon	1" to 100" (25mm to 2500mm)	2.00" (50mm)
Polyethylene (HDPE)	1" to 100" (25mm to 2500mm)	2.00" (50mm)
Polyethylene (LDPE)	1" to 100" (25mm to 2500mm)	1.00" (25mm)
Polypropylene	1" to 100" (25mm to 2500mm)	.500" (13mm)
PVC / CPVC	1" to 100" (25mm to 2500mm)	2.00" (50mm)
304 Stainless Steel	2" to 100" (63mm to 2500mm)	.500" (13mm)
304L Stainless Steel	2" to 100" (63mm to 2500mm)	.500" (13mm)
316 Stainless Steel	2" to 100" (63mm to 2500mm)	.500" (13mm)
Steel (1% carbon hard)	2" to 100" (63mm to 2500mm)	.500" (13mm)
Steel (carbon)	2" to 100" (63mm to 2500mm)	.500" (13mm)
Titanium	2" to 100" (63mm to 2500mm)	.500" (13mm)

Note: Consult the factory for an updated list of pipe materials.

Accuracy

Flow Rate Averaging Time	Transit Time Accuracy at at Nominal Pipe Sizes
5.0 Seconds (default setting)	+/-1% of rate > 1 ft/sec +/-0.01 ft/sec < 1 ft/sec
1.0 Seconds	+/-1% of rate > 5 ft/sec +/-0.05 ft/sec < 5 ft/sec
0.5 Seconds	+/-2% of rate > 12 ft/sec +/-0.25 ft/sec < 12 ft/sec

Flow Rate Averaging Time	Doppler Accuracy at Nominal Pipe Sizes 3/4" to 100" nominal pipe size
5.0 Seconds (default setting)	+/-2% of rate > 12 ft/sec +/-0.25 ft/sec < 12 ft/sec
1.0 Seconds	+/-2% of rate > 12 ft/sec +/-0.25 ft/sec < 12 ft/sec
0.5 Seconds	+/-2% of rate > 12 ft/sec +/-0.25 ft/sec < 12 ft/sec

Shipping Specifications

Carton Dimensions: 21" x 17" x 9-1/2"

Carton Weight: 24 lbs. (10.9 Kg.)

SPU (Signal Processing Unit)

Enclosure

NEMA 4X (IP66), Powder coated aluminum, SS clamps and hardware.
Dimensions: 11.00H x 8.60W x 5.00D inches (279H x 218W x 127D mm)

Weight 9.5 lb. (4.3 Kg.)

Mounting

Wall, pipe (vertical or horizontal) or panel mounting. Hardware included.

Panel opening: 10.63H x 8.10W inches (270H x 206W mm)

Panel Depth. Rear: 2.78 inches (71 mm), Front : 2.18 inches (55 mm)

Power Requirements

110-240 VAC 50/60Hz or 15-30 VDC; 40 watts maximum

Operating Temperature

14°F to 140°F (-10°C to 60°C) **Storage:** -40°F to 158°F (-40°C to 70°C)

Display

320 x 240 pixel QVGA backlit LCD, UV resistant.

Simultaneous Rate and Total: 10 digit maximum + exponent to E+32

Decimal location configurable to 10 places.

Display Languages

English, Spanish, French or German selectable.

Keypad

Five-button positive action tactile switch keypad.

Security

Programmable master password and individual configuration passwords.

Display Volume Units

Independently configurable Rate and Total display units in: U.S. Gallons, ounces, barrels (US liquid), barrels (US oil), cubic feet, acre feet, Imperial (British) gallons, liter, cubic meter, or user defined "custom" units. Rate display in feet or meters per second.

Display Time Units

Seconds, minutes, hours, days.

Display/Output Update Time

Selectable: 0.25, 0.50, 1.0 (default), 2.5, 5.0 seconds.

Flow Rate Display Averaging

Selectable: 0.50, 1.0, 2.5, 5.0 (default), 10.0 seconds.

Data Outputs

- Isolated 4-20 mA output - fully configurable, invertible (maximum load 1000 ohm resistance)
- 0-1000 Hz Open collector pulse output - fully configurable, invertible (5-30 Vdc, 50% duty cycle)

Data Logging

Date/time stamped flow rate and total data in FAT32 file format, easily imported into Excel. Configurable to trigger on time interval (1-999,999 sec), rate and/or total set-point values. Over 500,000 log events possible with included 32MB SD Card.

Process Control

Three independently configurable 10 amp Form C, NO/NC relays.

- Configure to flow rate for high/low/range rate alarm. Programmable release values enable auto release or manual latching operation.
- Configure to flow total for manual trigger batch operations or automatically triggered, timed batch operations.

External Communications

Computer connection via RS-232, RS485, USB, Ethernet.

- Includes user communication and configuration software
- Permits remote internet access through local network set-up
- Remotely access and upload data logging files.

Clamp-On Transducers

Housing

NEMA 6P (IP67), Nickel plated aluminum, ss clamps & hardware.

Dimensions: 3.12H x 2.95W x 1.60D in. (79H x 75W x 41D mm)

Weight (excluding cable): 0.8 lb. (0.4 kg.) each

Cable

Shielded coaxial RG/U Type:59. PVC jacket, black. RoHS Compt.

Standard length: 10 ft. (3m)

Optional lengths available: 25 ft. (7m), 50 ft. (15m), 100 ft. (30m)

Nominal Pipe Sizes

A series transducer: 1.0 inch - 100 inch (63mm to 2500mm)

Pipe Surface Temperature

-20°F to 250°F (-34°C to 121°C)

10.4 Pipe dimensional data

Pipe Size	ASTM D 1785 I.P.S. Pipe Size Schedules Wall (inches)																ASTM D 2241 Pressure rated pipe Wall (inches)			BS 3505 PVC-U Pressure Pipe Wall (inches)					
	Dn	O.D.	5s	5	10s	10	20	30	40s & Std.	40	60	80s & XH	80	100	120	140	160	XXH	SDR 41	SDR 26	SDR 21	Class B	Class C	Class D	Class E
2	2.375	.065	.065	.109	.109			.154	.154		.218	.218				.344	.436		.091	.113		.118	.145	.177	
2 1/2	2.875	.083	.083	.120	.120			.203	.203		.276	.276				.375	.522		.110	.137		.141		.220	
3	3.500	.083	.083	.120	.120			.216	.216		.300	.300				.438	.600		.135	.167		.122	.161	.208	.255
3 1/2	4.000	.083	.083	.120	.120			.226	.226		.318	.318						.636	.154	.190					
4	4.500	.083	.083	.120	.120			.237	.237	.281	.337	.337		.438		.531	.674		.173	.214		.141	.204	.267	.326
5	5.563	.109	.109	.134	.134	.203		.258	.258		.375	.375		.500		.625	.750		.214	.265		.157	.248	.326	.397
6	6.625	.109	.109	.134	.134	.203		.280	.280		.432	.432		.562		.719	.864		.255	.316		.189	.295	.389	.480
8	8.625	.109	.109	.148	.148	.250	.277	.322	.322	.406	.500	.500	.594	.719	.812	.906	.875		.332	.410		.220	.346	.456	.555
10	10.750	.134	.134	.165	.165	.250	.307	.365	.365	.500	.500	.594	.719	.844	1.000	1.125	1.000		.413			.275	.429	.563	.688
12	12.750	.156	.165	.180	.180	.250	.330	.375	.406	.562	.500	.688	.844	1.000	1.125	1.312	1.000		.490			.322	.507	.669	.818
14	14.000	.156		.188	.250	.312	.375	.375	.438	.594	.500	.750	.938	1.094	1.250	1.406			.538			.354	.555	.732	.897
16	16.000	.165		.188	.250	.312	.375	.375	.500	.656	.500	.844	1.031	1.219	1.438	1.594			.615			.401	.637	.830	1.023
18	18.000	.165		.188	.250	.312	.438	.375	.562	.750	.500	.938	1.156	1.375	1.562	1.781		.439	.692		.468	.716	.937		
20	20.000	.188		.219	.250	.375	.500	.375	.594	.812	.500	1.031	1.281	1.500	1.750	1.969		.488	.769		.519	.795			
22	22.000			.250	.375	.500	.375		.875	.500	1.125	1.375	1.625	1.875	2.125										
24	24.000	.219		.250	.250	.375	.562	.375	.688	.969	.500	1.219	1.531	1.812	2.062	2.344		.585	.923		.618	.948			
26	26.000			.312	.500		.375			.500															
28	28.000			.312	.500	.625	.375																		
30	30.000	.250		.312	.312	.500	.625	.375		.500															
32	32.000			.312	.500	.625	.375	.688		.500															
34	34.000			.312	.500	.625	.375	.688		.500															
36	36.000			.312	.500	.625	.375	.750		.500															
42	42.000					.375	.375		.500																
48	48.000					.375	.375		.500																

Pipe Size	ANSI/AWWA C151/A21.51 Ductile Iron Pipe Thickness Class Wall (inches)								ANSI/AWWA C151/A21.51 Ductile Iron Pipe Pressure Class Wall (inches)					AWWA C900 / C905 PVC Water pipe Wall (inches)			
	Dn	O.D.	50	51	52	53	54	55	56	150	200	250	300	350	DR 25	DR 18	DR 14
4	4.80		.26	.29	.32	.35	.38	.41					.25	.192	.267	.343	
6	6.90	.25	.28	.31	.34	.37	.40	.43					.25	.276	.383	.493	
8	9.05	.27	.30	.33	.36	.39	.42	.45					.25	.362	.503	.646	
10	11.10	.29	.32	.35	.38	.41	.44	.47					.26	.444	.617	.793	
12	13.20	.31	.34	.37	.40	.43	.46	.49					.28	.528	.733	.943	
14	15.30	.33	.36	.39	.42	.45	.48	.51			.28	.30	.31	.612	.850		
16	17.40	.34	.37	.40	.43	.46	.49	.52			.30	.32	.34	.696	.967		
18	19.50	.35	.38	.41	.44	.47	.50	.53			.31	.34	.36	.780	1.083		
20	21.60	.36	.39	.42	.45	.48	.51	.54			.33	.36	.38	.864	1.200		
24	25.80	.38	.41	.44	.47	.50	.53	.56			.33	.37	.40	.43	1.032		
30	32.00	.39	.43	.47	.51	.55	.59	.63	.34	.38	.42	.45	.49				
36	38.30	.43	.48	.53	.58	.63	.68	.73	.38	.42	.47	.51	.56				
42	44.50	.47	.53	.59	.65	.71	.77	.83	.41	.47	.52	.57	.63				
48	50.80	.51	.58	.65	.72	.79	.86	.93	.46	.52	.58	.64	.70				
54	57.56	.57	.65	.73	.81	.89	.97	1.05	.51	.58	.65	.72	.79				
60	61.61								.54	.61	.68	.76	.83				
64	65.67								.56	.64	.72	.80	.87				

Pipe Dimensional Data

Pipe Size		DIN 8062 PVC-U Pipe Wall (millimeters)				
Dn	O.D.	PN 4	PN 6	PN 10	PN 16	PN 20
63	63		1.9	3.0	4.7	7.0
75	75	1.8	2.2	3.6	5.6	8.4
90	90	1.8	2.7	4.3	6.7	10.0
110	110	2.2	3.2	5.3	8.2	12.3
125	125	2.5	3.7	6.0	9.3	
140	140	2.8	4.1	6.7	10.4	
160	160	3.2	4.7	7.7	11.9	
180	180	3.6	5.3	8.6	13.4	
200	200	4.0	5.9	9.6	14.9	
225	225	4.5	6.6	10.8	16.7	
250	250	4.9	7.3	11.9	18.0	
280	280		8.2	13.4	20.8	
315	315	6.2	9.2	15.0	23.4	
355	355					
400	400		11.7	19.1	29.7	
450	450					
500	500		14.6	23.9		
560	560					
630	630		18.4			

Tube Size		ASTM B 88 Copper Tube Type Sizes Wall (inches)		
Dn	O.D.	K	L	M
2	2.125	.083	.070	.058
2.5	2.625	.095	.080	.065
3	3.125	.109	.090	.072
3.5	3.625	.120	.100	.083
4	4.125	.134	.110	.095
5	5.125	.160	.125	.109
6	6.125	.192	.140	.122
8	8.125	.271	.200	.170
10	10.125	.338	.250	.212
12	12.125	.405	.280	.254

Tube Size		ASTM A269/A270 SS Tube Gauge Sizes Wall (inches)		
Dn	O.D.	16	14	12
2	2.000	.065	.083	.109
2.5	2.500	.065	.083	.109
3	3.000	.065	.083	.109
4	4.000	.065	.083	.109
6	6.000	.065	.083	.109

10.5 Sound speed data

Fluid Sound Speeds

Fluid	Temp. (°C)	Sound Speed (m/s)
1, 1, 1-trichloroethane	25	985
1-propanol	20	1222
Acetone (Dimethyl ketone; 2-propanone)	20	1190
Alcohol (Ethyl alcohol; Ethanol)	25	1207
Benzene	25	1306
Bromine	25	889
Butyl acetate	20	1270
Carbon dioxide	-37	839
Carbon tetrachloride	20	938
Chlorobenzene	20	1289
Chloroform	20	931
Diethyl ether	25	985
Diethyl Ketone	20	1310
Diethylene glycol	25	1586
Ether	20	1006
Ethyl acetate	25	1164
Ethyl ether	25	985
Ethylene glycol	25	1658
Ethylene glycol / water (50%)	25	1578
Gasoline	25	1250
Glycerol	25	1904
Iso-butane	25	1220
Isobutanol	25	1212
Isopropyl alcohol	20	1170
Kerosene	25	1324
Linalool	20	1400
Linseed Oil	20	1770
Methyl acetate	25	1181
Methyl alcohol (Methanol)	25	1076
Methyl ethyl Ketone	20	1210
Methylene chloride	25	1070
Milk, homogenized	25	1548
m-xylene	20	1343
n-butane	-5	1085
n-propyl acetate	2	1280
Octane	25	1172
Oil, (Lubricating X200)	25	1530
Oil, castor	25	1477
Oil, diesel	25	1250
Oil, motor (SAE 20/30)	20	1487
Oil, olive	25	1431
Oil, Paraffin	20	1420
Oil, peanut	25	1458
Oil, Transformer	20	1390
o-xylene	25	1332
Pentane	25	1020
Petroleum	20	1290
Refrigerant 11	0	828
Refrigerant 113	0	784
Refrigerant 114	-10	665
Refrigerant 115	-50	656
Refrigerant 12	-40	774
Refrigerant 14	20	875
Refrigerant 21	0	891
Refrigerant 22	50	894
Refrigerant C318	-10	574
Silicone (30cp)	25	990
Solvesso #3	25	1370
Tetrachloroethane	20	1170
Toluene	20	1328
Trichloroethylene	20	1050
Turpentine	25	1255
Water (distilled; waste)	20	1481
Water, heavy	20	1388
Water, sea	20	1520
Wood alcohol	25	1076

Pipe Sound Speeds

Pipe Material	Sound Speed (m/s)
Acrylic	2730
Aluminum	3080
Brass (Naval)	2050
Copper	2260
Copper (annealed)	2325
CuNi (70%Cu 30%Ni)	2540
CuNi (90%Cu 10%Ni)	2060
FRP (fiberglass reinforced plastic)	2505
Glass, Pyrex	3280
Inconel	3020
Iron (cast)	2460
Iron (ductile)	3000
Monel	2720
Nickel	2960
Nylon	2400
Polyethylene (HDPE)	2310
Polyethylene(LDPE)	1940
Polypropylene	2400
PVC/CPVC	2400
PVDF	2299
Stainless Steel 302/303	3120
Stainless Steel 304	3206
Stainless Steel 304L	3070
Stainless Steel 316	3175
Stainless Steel 347	3100
Stainless Steel 410	2990
Stainless Steel 430	3360
Steel (1% Carbon)	3220
Steel (1% Carbon, hardened)	3150
Steel (carbon)	3206
Steel (mild)	3235
Tin, rolled	1670
Titanium	3125
Tungsten, annealed	2890
Zinc, rolled	2440

Liner Sound Speeds

Material	Sound Speed (meters/sec)
Concrete (Mortar)	2500

Water Sound Speeds

Temp °C	Temp °F	Sound Speed (meters/sec)
0	32	1403
5	41	1427
10	50	1447
20	68	1481
30	86	1507
40	104	1526
50	122	1541
60	140	1552
70	158	1555
80	176	1555
90	194	1550
100	212	1543

10.6 Troubleshooting guide

TROUBLESHOOTING GUIDE		
Description	Possible Causes	Solution
Only 1 or 2 bars are displayed on the Goodness of Measurement reliability index	<ul style="list-style-type: none"> The transducers are not positioned properly. 	<ol style="list-style-type: none"> Check the separation distance measurements and reposition the transducers. See section 4.4.
	<ul style="list-style-type: none"> Sound beam is deflected by a rough exterior pipe surface. 	<ol style="list-style-type: none"> Check the transducer alignment. See section 4.10.
	<ul style="list-style-type: none"> Sound beam is deflected by a rough inside pipe wall surface caused by rust, weld seam, particle build-up, etc. 	<ol style="list-style-type: none"> Sand the pipe surface until smooth. See section 4.5. Clean or replace the pipe section. See section 4.5.
	<ul style="list-style-type: none"> The configured fluid is incorrect. The fluid may contain other fluids or chemicals that have altered the fluid sound speed. Extreme temperature variances also affect the sound speed. 	<ol style="list-style-type: none"> Use the "custom fluid" configuration and manually input the fluid sound speed. See section 7.2.4.
	<ul style="list-style-type: none"> Insufficient size, volume, and/or type of particles present for Doppler measurement. 	<ol style="list-style-type: none"> Switch to the Transit Time operating mode. See section 3.6.
	<ul style="list-style-type: none"> Too many particles present for Transit Time measurement. Configuration is incorrect. 	<ol style="list-style-type: none"> Switch to the Doppler operating mode. See section 3.6. Check the pipe material, pipe OD, pipe wall, and fluid configurations and reposition transducers if required. See section 6.3.2.
Measurement error suspected	<ul style="list-style-type: none"> Pipe OD and wall thickness configuration is incorrect. 	<ol style="list-style-type: none"> Configure the pipe OD and wall thickness correctly. See section 6.3.2.
	<ul style="list-style-type: none"> Low velocity flow rate attempted in Doppler mode. 	<ol style="list-style-type: none"> Fluid particles are moving slower than the fluid velocity, perhaps falling out of suspension in the fluid. Increase flow velocity.
	<ul style="list-style-type: none"> In upward vertical flow, bubbles are moving faster than fluid velocity. 	<ol style="list-style-type: none"> Switch transducer location to horizontal pipe. See section 4.1.
Transit Time: Displayed fluid sound speed does not agree with published fluid sound speed	<ul style="list-style-type: none"> The configured fluid is incorrect. The fluid may contain other fluids or chemicals that have altered the fluid sound speed. Extreme temperature variances also affect the sound speed. 	<ol style="list-style-type: none"> Use the "custom fluid" configuration and manually input the fluid sound speed. See section 7.2.4. See section 6.3.3 to configure the allowable percentage of error and the resulting alarm status (cause Warning or cause Fault).
	<ul style="list-style-type: none"> The transducers are not positioned properly. 	<ol style="list-style-type: none"> Check the separation distance measurements and reposition the transducers. See section 4.4. Check the transducer alignment. See section 4.10.
Flow rate display is jumpy	<ul style="list-style-type: none"> Pulsating flow. 	<ol style="list-style-type: none"> Flow rate display average set too low. Increase the DISPLAYÆ FLOW RATE AVERAGING setting. See section 6.3.3. Install a pulsation dampener in the piping system.
	<ul style="list-style-type: none"> Electrical interference. 	<ol style="list-style-type: none"> Move the transducers and SPU away from electrical noise source.
	<ul style="list-style-type: none"> Flow velocity is at or below the velocity limit of .25 feet per second. 	<ol style="list-style-type: none"> Perform a zero calibration. See section 2.8. Increase the fluid velocity.
	<ul style="list-style-type: none"> Too many decimal places displayed. 	<ol style="list-style-type: none"> Decrease the FLOW RATEÆ DIGITS AFTER DECIMAL POINT setting. See section 6.3.3.
	<ul style="list-style-type: none"> The clear total function is disabled in the configuration. 	<ol style="list-style-type: none"> Enable clear total in FLOW TOTALÆ TOTAL DISPLAY FUNCTION setting. See section 6.3.3.
USB port does not work	<ul style="list-style-type: none"> Latency timer setting on the PC must be adjusted. 	<ol style="list-style-type: none"> With the meter connected to the USB port, on the PC navigate to Control Panel / Systems and maintenance / Device Manager. Select PORTS. Double click USB CONVERTER. Select the PORT SETTINGS tab. Click ADVANCED. Set LATENCY TIMER to a value of 1. Save settings. See section 9.2.2.

10.6 Troubleshooting guide

TROUBLESHOOTING GUIDE – Warning codes		
Flow measurement continues during a warning code condition		
Warning Code	Possible Causes	Solution
W11	Receive signal near lower limit of operation	<ol style="list-style-type: none"> 1. Check the separation distance measurements and reposition the transducers. See section 4.4. 2. Check the transducer alignment. See section 4.10.
		<ol style="list-style-type: none"> 1. Sand the pipe surface until smooth. See section 4.5. 1. Clean or replace the pipe section. See section 4.5.
		<ol style="list-style-type: none"> 1. Place acoustic coupling material (gasket or silicone lubricant) between the transducers and the pipe surface. See section 4.9.
		<ol style="list-style-type: none"> 1. See section 1.9 for size limits. 1. Check the pipe material, pipe OD, pipe wall, and fluid configurations and reposition transducers if required. See section 6.3.2.
		<ol style="list-style-type: none"> 1. Increase the sound travel distance by changing the mounting mode from Z to V, or from V to W. See section 4.0.
W12	Receive signal too strong	<ol style="list-style-type: none"> 1. Use the “custom fluid” configuration and manually input the fluid sound speed. See section 7.2.4. 2. See section 6.3.3 to configure the allowable percentage of error and the resulting alarm status (cause Warning or cause Fault).
W13	Transit Time: Measured speed-of-sound exceeds allowable error limit (user configurable)	<ol style="list-style-type: none"> 1. Check the separation distance measurements and reposition the transducers. See section 4.4. 2. Check the transducer alignment. See section 4.10.
W16	Transit time burst onset detected with low confidence	<ol style="list-style-type: none"> 1. Check the pipe material, pipe OD, pipe wall, and fluid configurations and reposition transducers if required. See section 6.3.2. 1. Use the “custom fluid” configuration and manually input the fluid sound speed. See section 7.2.4.
W17		<ol style="list-style-type: none"> 1. Switch to the Doppler mode. See section 3.6.
		<ol style="list-style-type: none"> 1. Sand the pipe surface until smooth. See section 4.5. 1. Clean or replace the pipe section. See section 4.5. 2. Reposition the transducers on the pipe. Be sure to position the transducers away from any weld seams or surface imperfections. See section 4.1.
		<ol style="list-style-type: none"> 1. Use the “custom fluid” configuration and manually input the fluid sound speed. See section 7.2.4.
		<ol style="list-style-type: none"> 1. Switch to the Doppler mode. See section 3.6.
		<ol style="list-style-type: none"> 1. Re-position the transducers. See section 4.0.
W18	Transit Time: Large gain in periodic receiver gain (signal strength) adjustment detected	<ol style="list-style-type: none"> 1. No corrections needed. The meter will increase and decrease the gain as required. 2. If the fluid properties have changed, the fluid configuration may need adjusted. 3. If the particle count in the fluid has increased, switch to the Doppler mode of operation. See section 3.6.
		<ol style="list-style-type: none"> 1. Re-position the transducers. See section 4.0.
		<ol style="list-style-type: none"> 1. Reconfigure the scaling offset to a value between 0.5 and 2.0. See section 6.3.3.
W37	Improbable scaling offset	<ol style="list-style-type: none"> 1. Reconfigure the scaling offset to a value between 0.5 and 2.0. See section 6.3.3.

10.6 Troubleshooting guide

TROUBLESHOOTING GUIDE - FAULT CODES		
Flow measurement is suspended during a fault code condition		
Fault Code	Description	Possible Causes
F15	Transit Time: Burst onset not detected	<ul style="list-style-type: none"> The transducers are not positioned properly. Configuration is incorrect. The configured fluid is incorrect. The fluid may contain other fluids or chemicals that have altered the fluid sound speed. Extreme temperature variances also affect the sound speed. In transit time mode, there are too many particles in the fluid. Sound beam is deflected by a rough exterior pipe surface. Sound beam is deflected by a rough inside pipe wall surface caused by rust, weld seam, particle build-up, etc.
F81	Receive signal too weak or absent	<ul style="list-style-type: none"> The transducers are not installed on the pipe. There is no fluid in the pipe. Acoustic coupling is missing. Pipe thickness and/or diameter limits are exceeded. The transducers are not positioned properly. Transducer cables are not connected to the circuitry. Configuration is incorrect.
F19	Improbable flow rate, greater than 40 feet per second velocity	<ul style="list-style-type: none"> The incorrect transit time burst onset is detected.
F91	Impossible pipe geometries	<ul style="list-style-type: none"> Configuration is incorrect.
F13	Transit Time: Measured speed-of-sound exceeds allowable error limit (user configurable)	<ul style="list-style-type: none"> The configured fluid is incorrect. The fluid may contain other fluids or chemicals that have altered the fluid sound speed. Extreme temperature variances also affect the sound speed.
		Solution <ol style="list-style-type: none"> Check the separation distance measurements and reposition the transducers. See section 4.4. Check the transducer alignment. See section 4.10. Check the pipe material, pipe OD, pipe wall, and fluid configurations and reposition transducers if required. See section 6.3.2, page 43. Use the "custom fluid" configuration and manually input the fluid sound speed. See section 7.2.4. Switch to the Doppler mode. See section 3.6. Sand the pipe surface until smooth. See section 4.5. Clean or replace the pipe section. See section 4.5. Install the transducers on the pipe. See section 4.0. Install the transducers on a section of pipe that is always full of fluid. The meter will automatically re-start when fluid is present. Place acoustic coupling material (gasket or silicone lubricant) between the transducers and the pipe surface. See section 4.9. See section 1.9 for size limits. Check the separation distance measurements and reposition the transducers. See section 4.4. Check the transducer alignment. See section 4.10. Be sure the transducer lead wires are secure in the terminal block and the terminal block is fully inserted into the circuit board socket. See section 3.7. Check the pipe material, pipe OD, pipe wall, and fluid configurations and reposition transducers if required. See section 6.3.2. Check the separation distance measurements and reposition the transducers. See section 4.4. Check the transducer alignment. See section 4.10. Check the pipe material, pipe OD, pipe wall, and fluid configurations and reposition transducers if required. See section 6.3.2. Pipe surface finish is bad. Sand the pipe surface until smooth. See section 4.5. Check the pipe OD, pipe wall, and pipe liner thickness configuration. See section 6.3.2. Use the "custom fluid" configuration and manually input the fluid sound speed. See section 7.2.4. See section 6.3.3 to configure the allowable percentage of error and the resulting alarm status (cause Warning or cause Fault).

Limited Warranty

- Blue-White Sonic-Pro flowmeters are warranted to be free from defects in material and workmanship for 24 months from date of factory shipment. WARRANTY COVERAGE IS LIMITED TO REPAIR OR REPLACEMENT OF THE DEFECTIVE FLOWMETER ONLY. UNDER NO CIRCUMSTANCES SHALL BLUE-WHITE BE LIABLE FOR ANY CONSEQUENTIAL OR INCIDENTAL LOSSES OR DAMAGES THAT SHOULD ARISE FROM THE USE OF THE FLOWMETER AND IN NO EVENT SHALL THE COMPANIES LIABILITY EXCEED THE PURCHASE PRICE PAID BY THE PURCHASER FOR THE PRODUCT.
- This warranty does not cover damage to the flowmeter that results from misuse or alterations, nor damage that occurs as a result of improper installation.
- Blue-White assumes no liability for the acceptability of the flowmeter in a specific application. THE USER MUST DETERMINE THE ACCEPTABILITY OF THE PRODUCT AND ITS FITNESS FOR USE IN THE SPECIFIC APPLICATION.
- Flowmeters are repaired at the factory only. Call or write the factory to receive a RMA (return materials authorization) number. Carefully pack the flowmeter to be returned and write the RMA number on the outside of the shipping carton. Include a brief description of the problem and the application.
- Prepay all shipping costs. The factory does not accept C.O.D. Shipments. Damage that occurs during shipping is the responsibility of the sender.



Users of electrical and electronic equipment (EEE) with the WEEE marking per Annex IV of the WEEE Directive must not dispose of end of life EEE as unsorted municipal waste, but use the collection framework available to them for the return, recycle, recovery of WEEE and minimize any potential effects of EEE on the environment and human health due to the presence of hazardous substances. The WEEE marking applies only to countries within the European Union (EU) and Norway. Appliances are labeled in accordance with European Directive 2002/96/EC. Contact your local waste recovery agency for a Designated Collection Facility in your area.



ProSeries™
by Blue-White Ind.