

CU-27  
AUGUST 9, 2005

Control Type 25SU5 Model 5011, 5012 and 5013  
Shown with Optional Display Module  
120V. 50/60Hz

## TYPE 25SU5-5011/5012/5013 FLAME SAFEGUARD FOR BURNER MANAGEMENT SYSTEMS

Scanner Type 45UV5 Models 1000, 1010, 1101  
Scanner Type 45RM1 Series  
Scanner Type 45RM2 Series  
Scanner Type 45RM4 Series  
Scanner Type 45FS1, 45UVFS1



**WARNING:** This bulletin is directed to the licensed boiler service technicians and professional combustion engineers who are experienced in the installation and operation of Fireye flame safeguard controls. Persons not experienced with Fireye flame safety products should contact the nearest Fireye representative, or a qualified service group for assistance. **IMPROPER INSTALLATION OF THESE PRODUCTS MAY BE HAZARDOUS TO LIFE AND PROPERTY.**

### DESCRIPTION

The FIREYE® Type 25SU5 Model 5011/5012/5013 Control, combined with Type 45UV5, 45RM1, 45RM2, 45RM4, 45FS1, or 45UVFS1 remote Flame Scanners, comprises a repetitive self-checking flame safeguard system that confirms flame presence and absence to provide reliable ignition and flame failure protection.

Dimensional drawings of the control, wiring base and scanners are shown in Figure 10. For detailed information on Type 45RM1 and Type 45RM2 Scanners, see Bulletin CU-26; for Type 45UV5 Scanners, see Bulletin CU-22; for Type 45RM4, see Bulletin CU-31; for type 45FS1, 45UVFS1 see Bulletin CU-32.

### APPLICATIONS

The Fireye 25SU5 Control enables construction of integrated safety interlock systems for single and multiple burner fired apparatus including power, industrial process, and electric utility furnaces and boilers that fire gas, oil, pulverized coal or a combination of fuels on a continuous basis. The 25SU5 Control may also be employed in the safety control circuits of supervised manual and semi-automatic burner management systems as the primary safety control. This flame safeguard system monitors flame to supervise burner and pilot performance throughout the entire burner load range.


During normal burner start-up and operation, the 25SU5 Control confirms flame presence and activates a sequence of auxiliary devices to indicate flame status and permit the delivery and ignition of fuel for continuous firing. Conversely, in the event of ignition failure during light-off or loss of flame while in operation, the control, in conjunction with external logic, initiates a burner shutdown procedure. Protective devices are automatically tripped to:

1. Confirm flame failure through visual indication and alarm.
2. Cut off ignition energy.
3. De-energize the fuel safety shutoff valves.

This routine helps to prevent unburned fuel from accumulating in the combustion chamber. A 25SU5 Control Internal Wiring Diagram is shown in Figure 7.



FIGURE 1.



DUST COVER


Type 25SU5-5011, - 5012, -5013 Control consists of:  
 60-2204-2 Chassis  
 60-2223 Dust Cover  
 60-2207-1 High Sensitivity Flame Amplifier Module for 5011  
 60-2207-2 High Discrimination Flame Amplifier Module for 5012  
 60-2207-3 High Sensitivity/Low Hysteresis Flame Amplifier Module for 5013  
 60-2301 Blank Display Module  
 48-1805 Mounting Screw

FLAME AMPLIFIER  
MODULE

CHASSIS  
ONLY


WIRING LABEL


OPTIONAL DISPLAY MODULE



SERIALNUMBER LABEL ON BOTTOM

The mounting screw must be removed to replace the Modules. This screw must be used to prevent electrical shock or damage to the control.





RIBBON CABLE 60-2367  
(Included with wiring base)

WIRING BASE  
P/N 60-2206-1  
(Ordered separately)

To remove the cover, place your fingers and palms on each side and pull forward as shown in the diagrams. Press down with thumbs while pulling out with your palms and fingers. The cover will snap off and can be snapped back into place easily.

*Note: A modernization Adapter, Fireeye P/N 60-2060-16, may be used when upgrading an older control (see Bulletin CU-28).*



## PRINCIPLES OF OPERATION

When flame is detected by a Fireye infrared or ultraviolet scanner, a pulse train is generated and transmitted to the 25SU5 Control via Fireye Scanner Cable. Pulses received are modified by a pulse shaping circuit and regulated by operator adjustment of the enabled sensitivity control. Increasing the sensitivity increases the signal level.

The flame signal is then fed to a comparator circuit. If the signal is greater than the comparator threshold, the output is amplified to energize the Flame Relay, which latches the Master Relay.

If the flame signal drops below the Flame Relay threshold or is absent for a period longer than the one or four second (max.) flame failure response time (FFRT), the Flame Relay drops out de-energizing the Master Relay. Similarly, the opening of any switch or interlock connected in series with the Master Relay will de-energize the Master Relay and commence a burner shutdown procedure.

### Notes:

1. The Flame Failure Response Time (FFRT) is selectable for 1 or 4 seconds, and is factory set at 4 seconds. See page 5 for details.
2. The flame failure response time (FFRT) remains constant regardless of the flame intensity prior to flameout.
3. On each start, a safe start check is performed. If flame (real or simulated) is detected, the Master Relay remains de-energized to prevent burner start-up.
4. The Master Relay is energized when the burner start pushbutton is depressed.

## FEATURES

### Sensitivity Control

“Sensitivity A” and “Sensitivity B,” are provided on the Flame Amplifier Module, P/N 60-2207-1,-2 or -3 to accommodate dual scanner applications or alternate fuels (refer to Figure 2). Sensitivity “A” or “B” is selected through use of an external selector switch connected to Terminals 27, 28 and 29 (see Figure 7). If “Sensitivity A” is to be used only, jumper terminal 27 to 28. For “Sensitivity B” only, jumper terminal 28 to 29. The wiring base is shipped with a jumper wire installed between terminals 27 and 28, selecting “Sensitivity A.” While two scanners may be connected to the 25SU5, their combined inputs are **both** channelled through the selected Sensitivity “A” or “B” circuit.

FIGURE 2.



Each sensitivity control is adjustable for regulating the signal level in excess of the Flame Relay threshold. Turning the sensitivity in the clockwise direction amplifies the flame signal such that each graduation yields a reading twice that of the preceding.

The sensitivity must be set so that the monitored burner produces a reading greater than the Flame Relay “Pull-In” voltage, (refer to figure 3). With the monitored flame out, flame from other burners and/or radiation from hot refractory should yield a reading not more than the Flame Relay “Drop-Out”. If the flame signal does not drop below the Flame Relay “Drop-Out” voltage when the flame is turned off, decrease the sensitivity to discriminate between the burner flame being monitored, adja-



cent burner flames and background radiation. If decreasing the sensitivity results in an insufficient meter reading, when the flame is on, resight the scanner to detect more of the flame being monitored. Normally, the flame signal can be adjusted for a reading of 2 volts and the control will be capable of detecting a flame failure in the presence of background radiation and adjacent burner flames. Discrimination between different burner flames is best with a reading below the saturation level of 2.85 volts.

*Note: Sensitivity setting does not affect the flame failure response time (FFRT).*

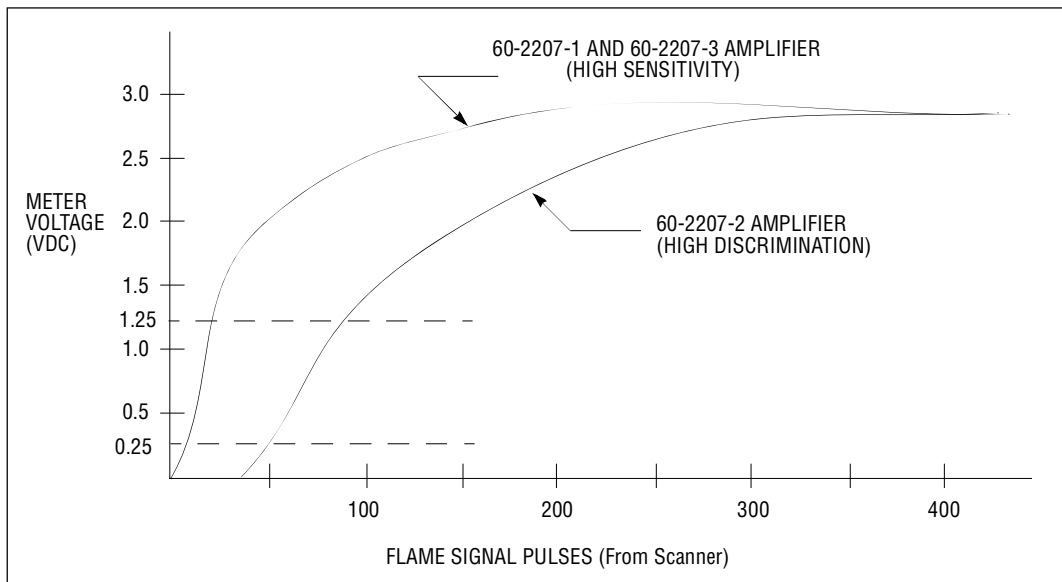
**Flame Amplifier Modules**

**60-2207-1 High Sensitivity Flame Amplifier Module** is packaged with the 25SU5-5011 control. The 60-2207-01 Amplifier is designed with a high sensitivity flame response curve, suitable for a single burner application when the *burner off* condition is a black boiler.

**60-2207-2 High Discrimination Flame Amplifier Module** is packaged with the 25SU5-5012 Control. The 60-2207-2 Amplifier is designed with a high discrimination flame response curve, suitable for a single or multi-burner application where background radiation (from adjacent flame tips, hot refractory, etc.) is present during the *burner off* condition.

**60-2207-3 High Sensitivity/Low Hysteresis Flame Amplifier Module** is package with the 25SU5-5013 control. The 60-2207-3 Amplifier is designed with a high sensitivity flame response curve, but without Flame Relay ON / Flame Relay OFF hysteresis of the 60-2207-1 Amplifier. This is suitable for single or multi-burner applications where there is a very small difference between flame on and flame off (background) signal strength.

**FIGURE 3. FLAME RESPONSE CURVES (shown with sensitivity set @ maximum)**



**METER/TEST JACK VOLTAGE**

FLAME RELAY	60-2207-1	60-2207-2	60-2207-3
Pull-In	1.25	0.80	1.25
Drop-Out	1.00	0.25	1.25

*NOTE: The listed pull-in and drop-out voltages are nominal and for reference only. The actual value may vary.*



### Flame Relay

The Flame Relay (RF) is a DC, flame proving relay having contacts brought out on terminals shown in Figure 7. This relay is energized when the following conditions are met:

1. The control is powered and
2. A pulsed flame signal greater than the Flame Relay threshold is being received.

The Flame Relay will automatically de-energize to counteract any of the following conditions:

1. Loss of power for a period greater than the flame failure response time (FFRT).
2. No flame signal within the FFRT.
3. Flame signal level falls below the Flame Relay threshold for the FFRT.
4. A scanner or electronic circuit fault is detected.

### Master Relay

The Master Relay (RM) is an AC load relay having contacts brought out on terminals shown in Figure 7.

It is energized when the burner start pushbutton is depressed, provided all external switches and interlocks connected in series are closed and flame is *not* present. The Master Relay is then latched at the time flame is detected, and the pushbutton may be released.

The action of the Master Relay contacts is such that undesired operational sequences are “locked out” or unattainable until the necessary conditions and sequences for energizing both the Master Relay and Flame Relay are satisfied. **Proper application of the Master Relay contacts when used in burner safety shutoff valve circuits for safe start-up and shutdown, is the responsibility of the system design engineer.**

### Self-Checking

The Fireye 25SU5 Control provides reliability in flame failure protection by repeatedly self-checking both scanner and control performance 12 times per minute **when flame is detected** to protect against a false flame signal due to failure of one of its component parts. Thus, when a failure is detected, the control initiates a burner shutdown procedure. This function is obtained with the Flame Relay in combination with an electromagnetic or electronic shutter in the associated Fireye Scanner.

The self-checking 25SU5 Control monitors both the open and closed periods of the shutter when flame is detected to cause the Flame Relay to drop out if any of the following conditions occur:

1. Power to the system is interrupted longer than the flame failure response time (FFRT).
2. A pulsed flame signal from the scanner is not detected within the FFRT.
3. The shutter stops in any position.
4. Failure of any component or wiring that simulates a continuously closed or open shutter.
  - a. Flame is not detected when the shutter is open for one FFRT.
  - b. Flame is detected when the shutter is closed for three FFRT.
5. Malfunction of the Flame Relay Circuit.

### Selectable flame failure response time

The chassis (P/N 60-2204-2) for the 25SU5 has a jumper to select either a 1 second or 4 second Flame Failure Response Time (FFRT). The chassis is shipped with a 4 second FFRT time. To change the FFRT time (see Figure 9):

1. Remove the amplifier module and relay cover.
2. Use long nose pliers and pull the black FFRT jumper straight out towards you. Move the plug left one slot to change from a 4 second (4s) to a 1 second (1s) FFRT.

### Replaceable Fuse

The chassis also has a replaceable fuse. The part number of the fuse is 23-93. The fuse is also available from Littlefuse (P/N 273 003). To replace the fuse (see Figure 9):

1. Remove the amplifier module and relay cover.
2. Use long nose pliers and pull the head of the fuse straight out towards you.



### Optional Meters/Test Jacks

An indication of signal strength can be obtained with a remote meter (see Accessories) or a 20,000 ohms per volt voltmeter on a 3 volt DC Scale at the (+) and (-) test jacks located on the Flame Amplifier Module or at terminals C/13(-) and 15(+) shown in Figure 7.

See Accessories section later in this document for a listing of available meters.

## OPTIONAL DISPLAY MODULE P/N 60-2205

### Bar Graph Display

The optional Display Module is equipped with a Bar Graph meter containing a vertical scale having ten light emitting diodes (LED's) numbered 1 through 10. Each successive LED up the scale represents a flame signal intensity twice the one before it, see the table below.

Highest LED Lit	Flame Signal Intensity Volts DC	Highest LED Lit	Flame Signal Intensity Volts DC
10	3.0	5	1.5
9	2.7	4	1.2
8	2.4	3	.9
7	2.1	2	.6
6	1.8	1	.3

When flame is present the Bar Graph will display "Lit" LED's up to and including the LED that corresponds with the flame signal intensity being produced.

### Marginal Alarm w/LED

The optional Display Module is equipped with a Marginal Alarm Relay (RA) having dry contacts brought out on terminals shown in Figure 7. This relay is energized only if:

1. The control is powered.
2. The Flame Relay is energized and
3. The Flame Signal is greater than the Marginal Alarm setpoint.

The Marginal Alarm Relay setpoint is adjustable via the LED/potentiometer located on the Display Module. The setpoint should be set high enough to allow time to obtain a stronger flame signal, but not so high that nuisance trips occur. If the flame signal becomes marginal the Marginal Alarm Relay will drop out to sound an external Marginal Alarm (not provided) and illuminate it's LED setpoint potentiometer.

CONDITION	MARGINAL RELAY	MARGINAL LED
FLAME RELAY DE-ENERGIZED	DE-ENERGIZED	ON
FLAME RELAY ENERGIZED, SIGNAL NOT MARGINAL	ENERGIZED	OFF
FLAME RELAY ENERGIZED, SIGNAL MARGINAL	DE-ENERGIZED	ON



**CAUTION: Do not exceed the 30 V (AC or DC) marginal alarm contact rating. Do not use contacts for safety related functions.**

### Flame Relay LED

The Flame Relay LED is "Lit" when the flame signal is greater than the Flame Relay threshold. The LED may also be used in diagnosing a runaway UV tube and/or shutter failure evidenced by the following:

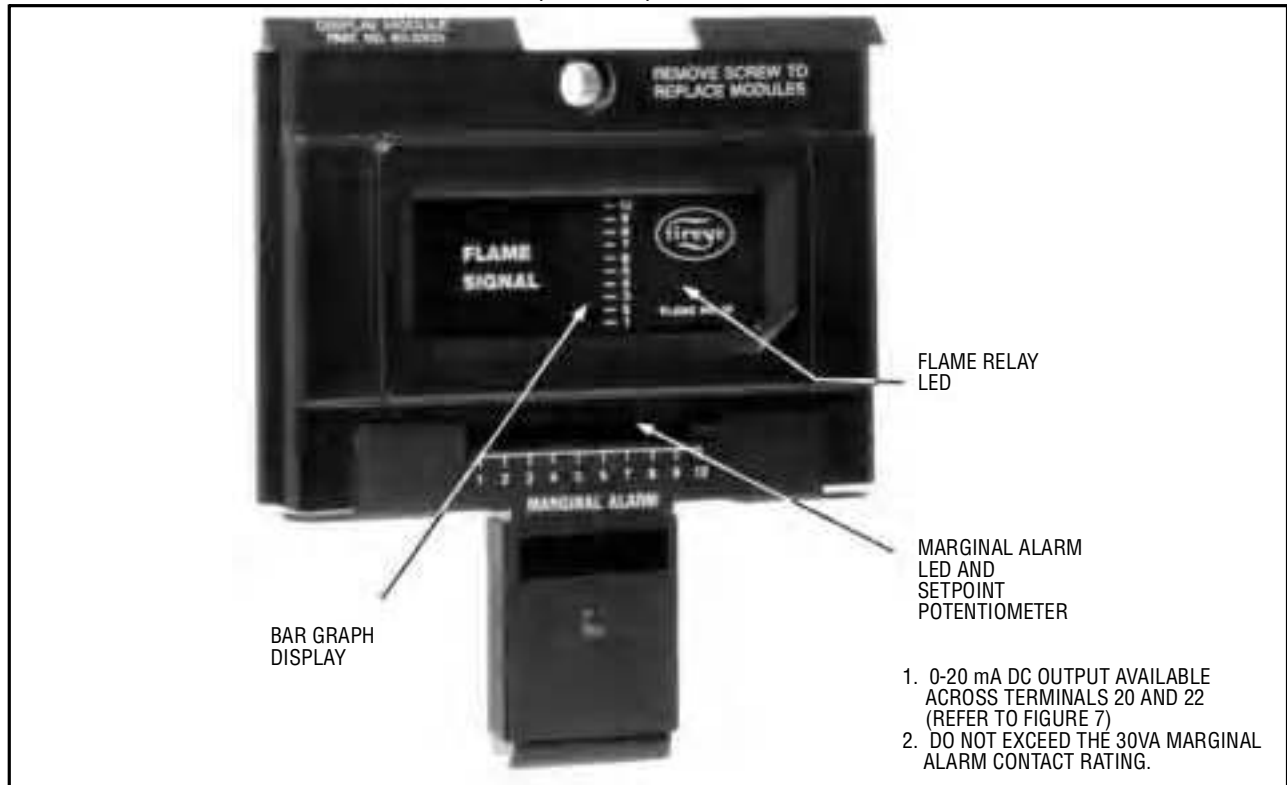
1. Flame Relay LED "Lit" and
2. Remote Flame out indicator "Lit" (terminal 10, Flame Relay de-energized.)



### 0-20 mA DC Output

A 0-20 mA DC output signal is provided across terminals 20 (+) and 22 (-) for connection of a meter or recorder (800 ohms maximum). The output is current sinking.

**FIGURE 4. DISPLAY MODULE P/N 60-2205 (OPTIONAL)**



## SPECIFICATIONS, 25SU5 MODELS 5011, 5012 AND 5013

**Supply Voltage:** 120 VAC (102 min., 132 max.) 50/60 Hz

**Maximum Flame Failure Response Time (FFRT):** Selectable 4 sec. or 1 sec. (Factory set at 4 sec.)

**Nominal Shutter Operating Cycle:** 4.5 sec. open / 0.5 sec. closed.

### Power Input

(With normal supply voltage and no loads connected to relay contacts)

Control with 1 scanner: 13VA, Power Factor 70% typ.

Inrush Current at turn-on: 2.5A instantaneous peak

Replaceable fuse: 3.0A P/N 23-93

### Operating Temperature

25SU5 Control: 125°F (52°C) max., 32°F (0°C) min., ambient

45UV5 Scanner: 200°F (93°C) max., -40°F (-40°C) min. at housing flange

45RM1 Scanner: 150°F (65°C) max., -40°F (-40°C) min. at housing flange

45RM2 Scanner: 150°F (65°C) max., -40°F (-40°C) min. at housing flange

45RM4 Scanner: 150°F (65°C) max., -40°F (-40°C) min. at housing flange

45FS1 Scanner: 150°F (65°C) max., -4°F (-20°C) min. at housing flange

45UVFS1 Scanner: 131°F (55°C) max., -4°F (-20°C) min. at housing flange



### Storage Temperature

Scanner and Control: 185°F (85°C) max., -40°F (-40°C) min.

### Maximum Load Permitted

Two Scanners of any combination  
 One remote meter (38-88)  
 One display module (60-2205)  
 One 0-20mA chart recorder or meter (800  $\Omega$  maximum)

### Shipping Weights

Type 25SU5	6 lbs.	(2.7 kg.)
Wiring Base P/N 60-2206-1	2 lbs.	(1 kg.)

### Electrical Rating Consideration

Electrical ratings of FIREYE controls, regardless of the terms in which they are stated, are based on normal circuit current in amperes multiplied by nominal circuit voltages, called voltamperes and abbreviated as VA.

Other electrical rating terms must be converted to VA when computing total connected load. If stated in amperes at a given voltage, multiply volts by amperes to get VA. If stated in horsepower, use the ampere figure specified in the National Electrical Code for that single phase horsepower at the appropriate voltage and convert to VA. If the connected load is rated in watts, convert to approximate VA by dividing the rating in watts by an appropriate factor as follows:

Magnetic coil (relay, solenoid valve, etc.).....	.35
Motor .....	.75
Resistor (electric heater, lamp, etc.).....	1.00

*(Example: for solenoid valve rated 14 watts, divide 14 by .35; approximate VA is 40).*

The types of load permissible under the various rating terms which may be applied to Fireeye controls as follows:

Running and Locked Rotor Amperes is a rating intended specifically for motors, but a non-pilot duty load (see below) may be applied if normal and inrush currents do not exceed running current rating. Also an indicator lamp may be combined with a motor load if the total of lamp inrush (figured at 10 times normal current) and motor locked rotor currents does not exceed the locked rotor rating.

VA Pilot Duty rating permits the connection of relays, solenoid valves, small motors, indicator lamps, and other electrical devices under the condition that normal operating VA may not exceed the rating. Inrush (or locked rotor) VA may not exceed ten times the rating.

The term "Inrush" as applied here relates ordinarily to a device wherein a part of the magnetic structure is free to assume two defined positions (such as a solenoid plunger) and signifies the current which flows in the short interval between energizing the coil and seating of the moveable structure in its energized position. The term also relates to resistive devices which operate at incandescent temperatures (such as a lamp) where the cold resistance is much less than the hot resistance and where accordingly the current during the short interval between energizing and incandescence is considerably higher than normal operating current.

There is no formula to convert AC ratings of isolated contacts to DC ratings. The use of contacts in DC circuits is not sanctioned unless DC rating is specified.

Ratings as they affect the contacts within the FIREYE control are established on the assumption that no contact will be required to carry inrush currents more often than once in fifteen seconds. The use of limit, interlock or operating control switches that do not make positive contact at closure and which give rise to "chattering" of relays within the FIREYE control or of devices energized through it may lead to premature failure of switching members in the control. Similarly, the contacts can not be expected to handle short circuit currents without possible damage. Therefore, it is of vital importance to make a "dry run" check of the control system (with manual fuel shut-off valves closed) following the automatic opening of a control system fuse or circuit breaker, or following any known instance of relay or switch chattering!





### LOAD RATINGS (MAXIMUM) FOR TYPE 25SU5

Terminal	Ratings at 120 volts, 60 Hz
6 - 10 - 12	125 VA Pilot Duty each
7	250 VA Pilot Duty or Motor: 9.8 amperes full load, 58.8 amperes locked rotor. Alternate Rating — 300 VA transformer; and 130 VA pilot duty; and maximum combined load of not more than 3 motorized valves: Holding — 180 VA Opening — 635 VA Locked Rotor — 730 VA
9	50 VA Pilot Duty
23 - 24 - 25	30 VA (for indication only)

*Note: Total load not to exceed 2000VA.*

### INSTALLATION



**CAUTION: Installer must be a trained safety control technician. Verify that electrical power is disconnected before starting installation.**

Installation of 45UV5 Scanner —	See Bulletin CU-22
Installation of 45RM1, 45RM2 Scanner —	See Bulletin CU-26
Installation of Fiber-Optic Scanner —	See Bulletin CU-21
Installation of 45RM4 Scanner —	See Bulletin CU-31
Installation of 45FS1/45UVFS1 —	See Bulletin CU-32

#### Installing the Type 25SU5 Control

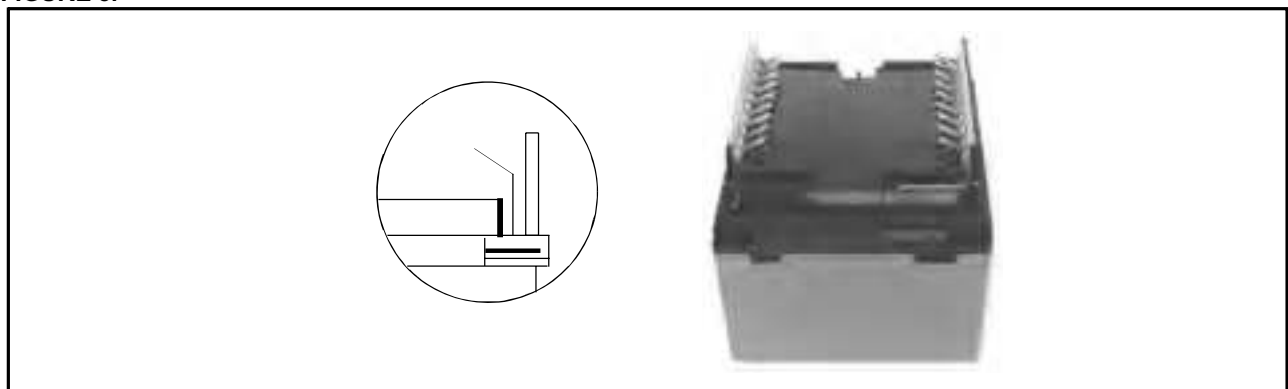
The 25SU5 Control can be plugged into the wiring base shown in Figure 1. Use the drilling dimensions given in Figure 10 to mount the wiring base on an upright surface that is flat and free from excessive vibration.

*Note: When upgrading a FIREYE Control, a Modernization Adapter, P/N 60-2060-16, may be used (See Bulletin CU-28).*

Before plugging in the chassis:

1. Check the electrical tabs on the bottom of the chassis — if they are bent out of position, reposition them with your fingers so that they are in line as shown in Figure 5.
2. Connect the external wiring to the wiring base terminals as indicated in the following section entitled “Control and Scanner Wiring.”

**FIGURE 5.**

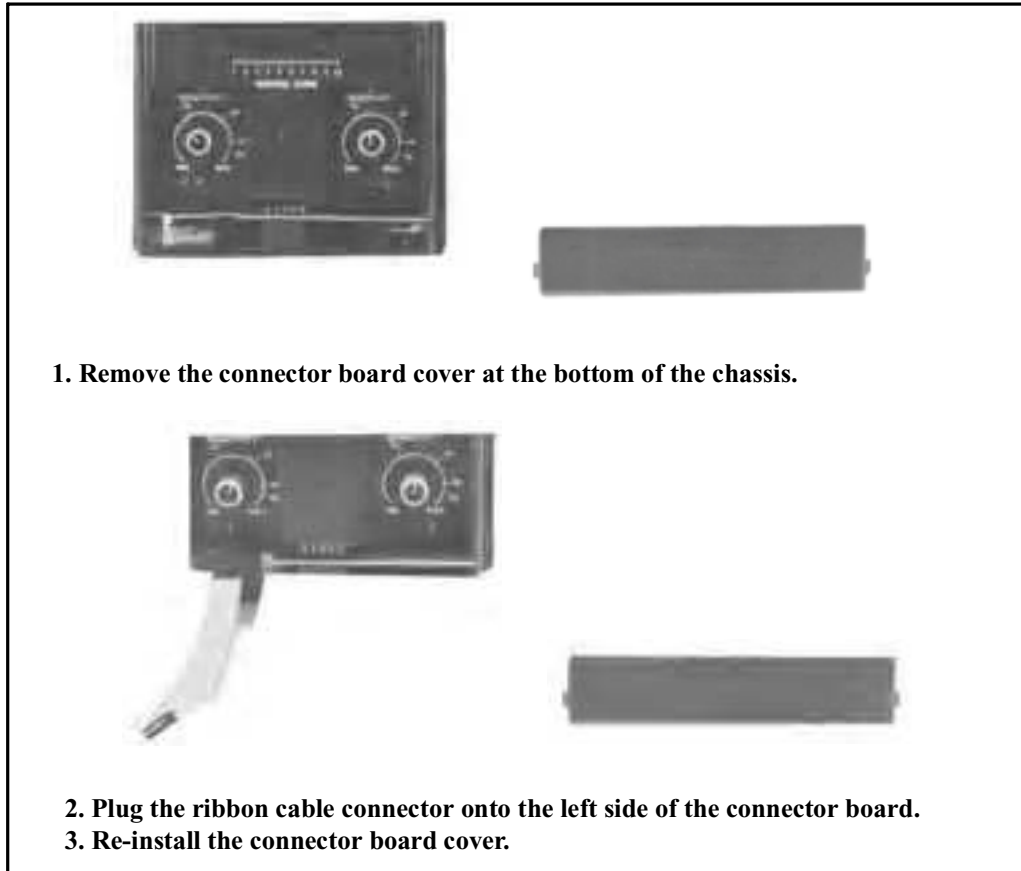


After all wiring connections are made:

1. Install the chassis into the wiring base and tighten the chassis Mounting Screw completely.
2. Connect the wiring base ribbon cable to the control's chassis as shown in Figure 6.



FIGURE 6.



### Control Wiring

Following approved engineered wiring diagrams, make wiring connections on the terminal strips provided within the wiring base. Connect bared wires directly to the screw terminals or use insulated lugs. All wiring should be enclosed in an approved raceway and must comply with the National Electrical Code and with local codes. Splices must be made only in troughs or junction boxes. Connect an earth ground wire to the screw provided in the wiring base. Provide external fuses, as required.

It is important that cross-phasing be prevented on multi-phase installations. The common of all control components (magnetic starter coil, ignition transformer, pilot and main fuel valves, etc.) powered by the 25SU5 Control must be connected to the common of the control, terminal 2.

### General Scanner Wiring

All wiring to the scanner must be rated for 600 volts and 90 C. Cable lengths in excess of 1000 ft. (305 M) are discouraged. To avoid electrical interference and ensure proper operation, the use of Fireeye shielded scanner cable, P/N 59-470 or 59-471, is strongly recommended.

When a Fireeye 45UV5 scanner is used *in conjunction with* any of the other listed Fireeye scanner types, (45RM1, 45RM2, 45RM4, 45FS1, 45UVFS1), a special blocking diode, (Fireeye P/N 101-78), must be installed in series with the lead from terminal 14 of the 45UV5 scanner as shown on the following wiring diagrams. Failure to do so will result in damage to the *other* listed scanner. If *two* 45UV5 scanners are used in conjunction, or if *any two non- 45UV5* scanner types are used, the diode is not required.



---

**45UV5, 45RM1, 45RM2 Scanners**

Attach 1/2" flexible conduit to the threaded connection provided on the scanner. Connect the four scanner cable wires to scanner terminals L or P (black/power), C (white/common), 1 (red/shutter), and 14 (green/signal). Do not connect the cable shield at the scanner. Connect the four scanner cable wires to the appropriate terminals within the 25SU5 wiring base. Connect the cable shield to terminal C at the wiring base.

An optional Scanner Connector Kit (P/N 60-2366) is available, providing a threaded electrical quick disconnect between the scanner and the Fireeye cable. Refer to bulletin CU-50 for details.

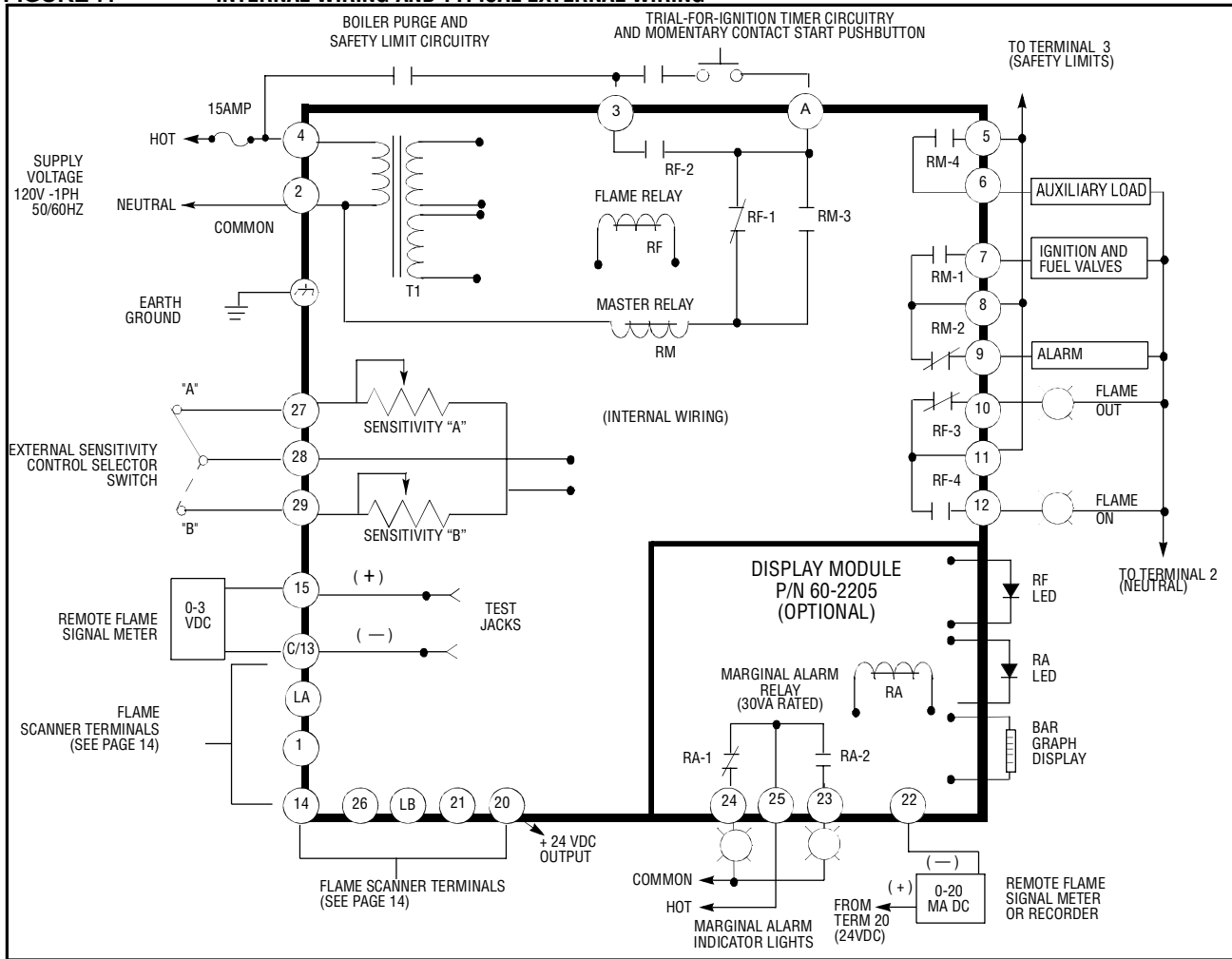
**45RM4, 45FS1, 45UVFS1 Scanners**

These scanners are provided with a threaded electrical quick disconnect installed on the scanner housing. Install the mating female cable connector (P/N 129-127-6, ordered separately), onto the Fireeye cable (P/N 59-470 or 59-471) per the instructions in the appropriate scanner bulletin. Alternately, order Fireeye Cable *Assemblies* (P/N 59-470-XXX or 59-471-XXX) which have the female cable connectors factory installed. Connect the four scanner cable wires (black, white, red, green) to the appropriate terminals within the 25SU5 wiring base. Connect the cable shield to terminal C at the wiring base.



**Important Note:** The external wiring shown in Figure 7 is **typical** and for information only. It is the responsibility of the System Design Engineer to design a reliable and safe system in compliance with any and all applicable codes.

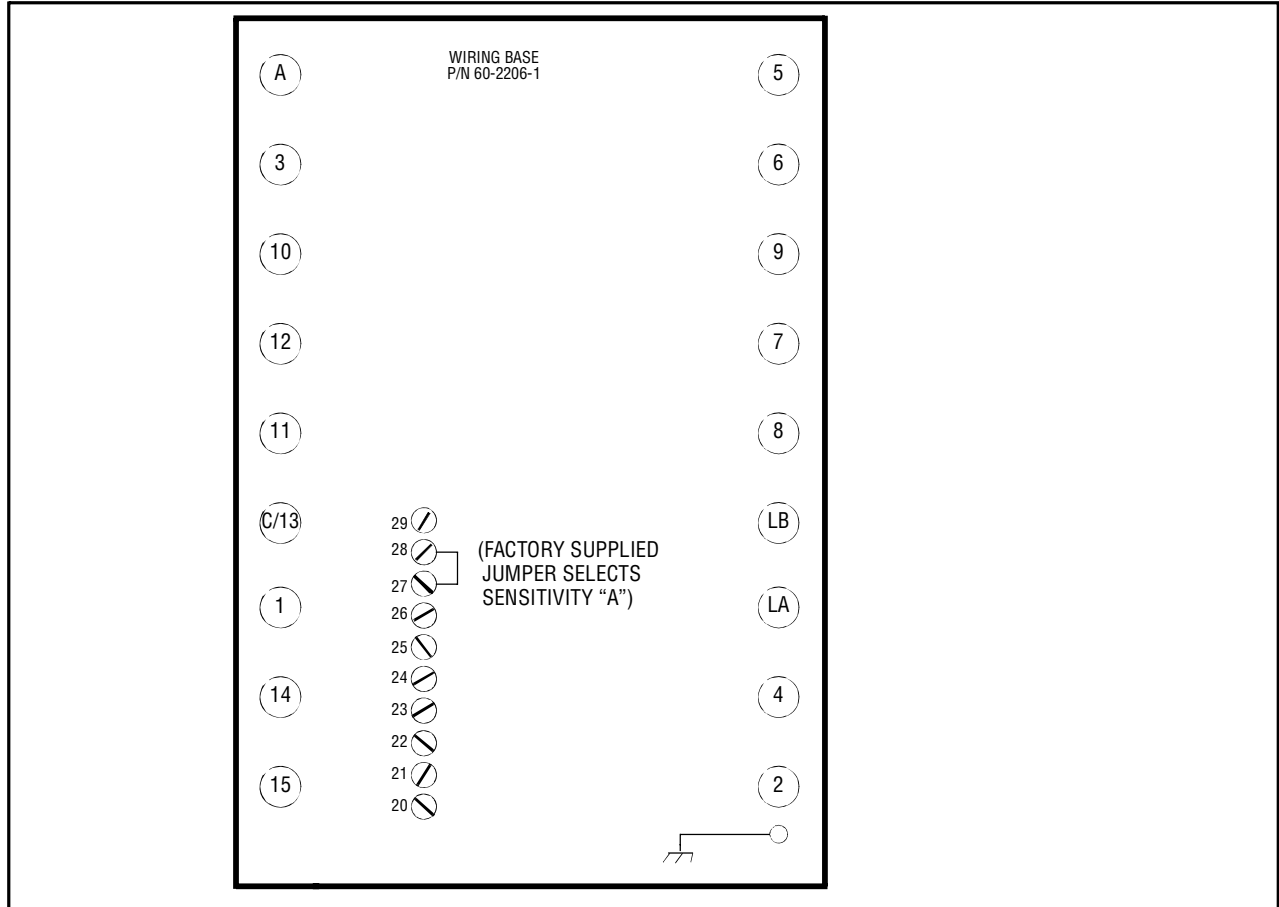
**FIGURE 7. INTERNAL WIRING AND TYPICAL EXTERNAL WIRING**



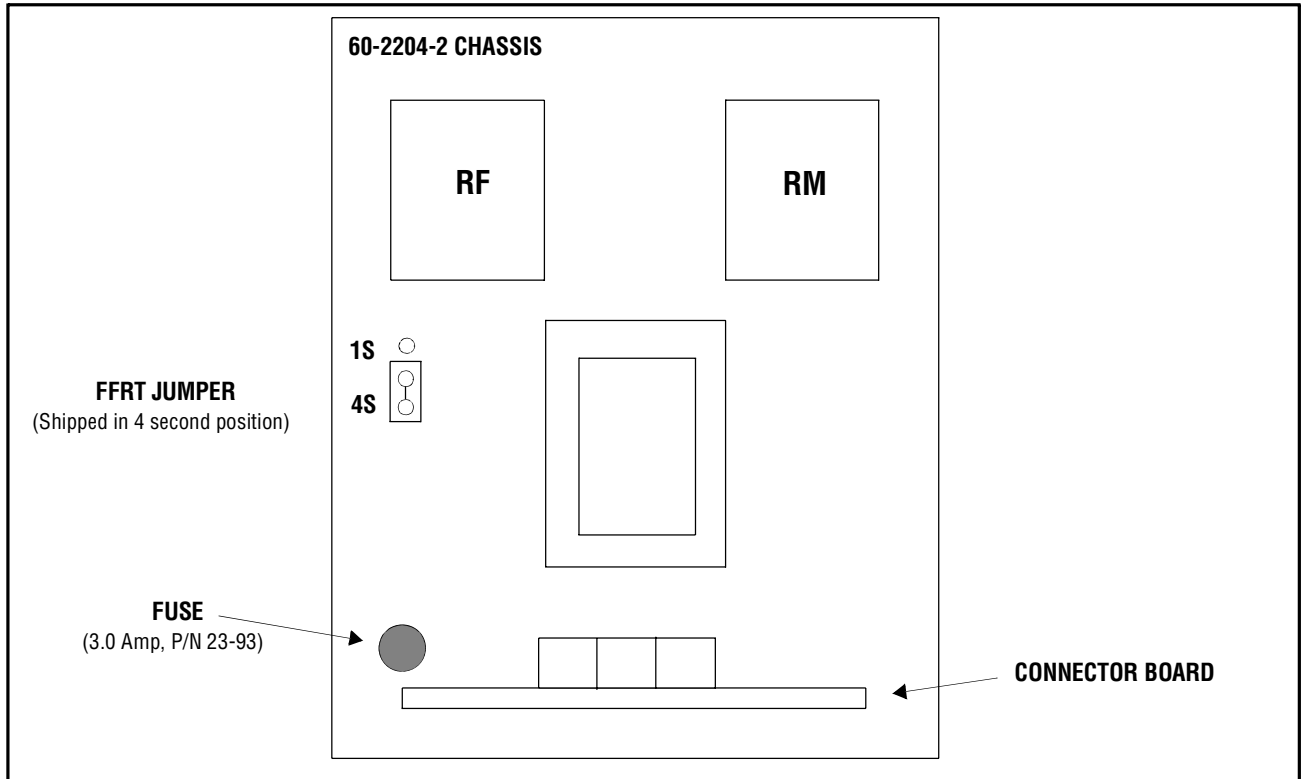
LEGEND		EXTERNAL CONNECTIONS	
ITEM	DESCRIPTION		
		1	SCANNER SHUTTER
RA	MARGINAL ALARM RELAY	2	LINE COMMON (NEUTRAL)
RM	MASTER AC RELAY	3-4	PURGE AND LIMIT CIRCUITS
RF	FLAME DETECTING RELAY	4	LINE (HOT)
T1	AMPLIFIER TRANSFORMER	5	HOT SUPPLY FOR TERM 6
		6	AUXILIARY LOAD
		7	MAIN LOAD (N.O)
		8	HOT SUPPLY FOR TERMS 7 & 9
		9	ALARM (N.C.)
		10	FLAME OUT INDICATOR (N.C.)
		11	HOT SUPPLY FOR TERMS 10 & 12
		12	FLAME ON INDICATOR (N.O.)
		14	SCANNER SIGNAL
		C/13-15	FLAME SIGNAL METER
		3-A	STARTING CIRCUIT
		LA	SCANNER A SUPPLY
		LB	SCANNER B. SUPPLY (60-2206-1 ONLY)
		20	+ 24VDC SCANNER POWER and 0-20mA SUPPLY
		21	SCANNER, COMMON
		22	0-20mA RETURN
		23-25	MARGINAL ALARM (N.O.)
		24-25	MARGINAL ALARM (N.C.)
		26	SCANNER, SHUTTER
		27	SENS A
		28	COMMON
		29	SENS B
			SENS. SELECTOR SWITCH (WIRING BASE 60-2206-1 ONLY. NOT AVAILABLE ON 60-2060-16 ADAPTER)



**FIGURE 8. TYPE 25SU5 MODEL 5011/5012 WIRING BASE TERMINAL LAYOUT**

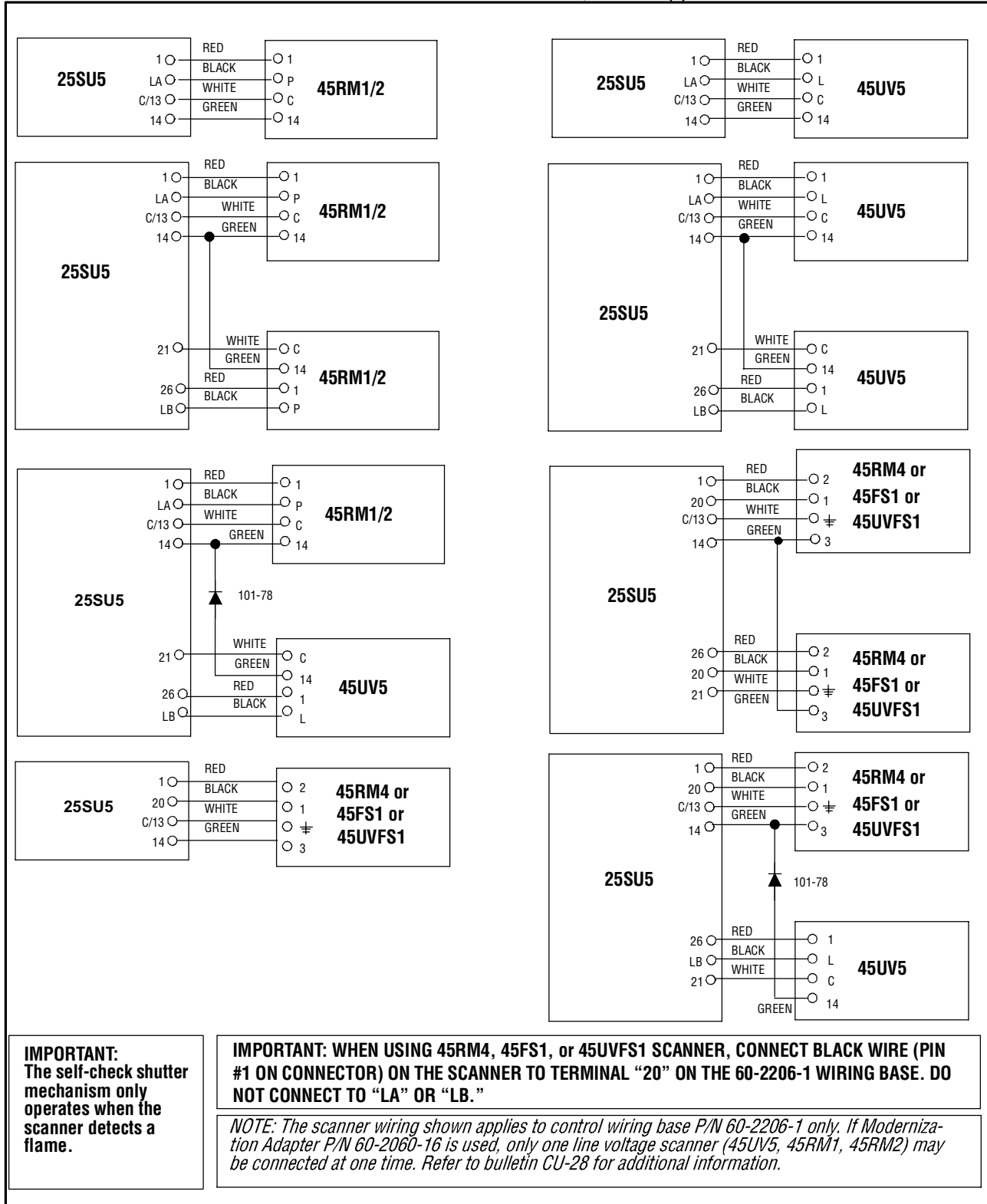


**FIGURE 9. FUSE AND FFRT JUMPER LOCATION**





**FIGURE 10. 25SU5-5011/5012/5013 FLAME SAFEGUARD CONTROL, SCANNER(S) WIRING COMBINATIONS**



**Note 1:** Diode part No. 101-78 must be connected as shown in signal lead (14) of the 45UV5 scanner when using with a 45RM, 45FS, or 45UVFS scanner.

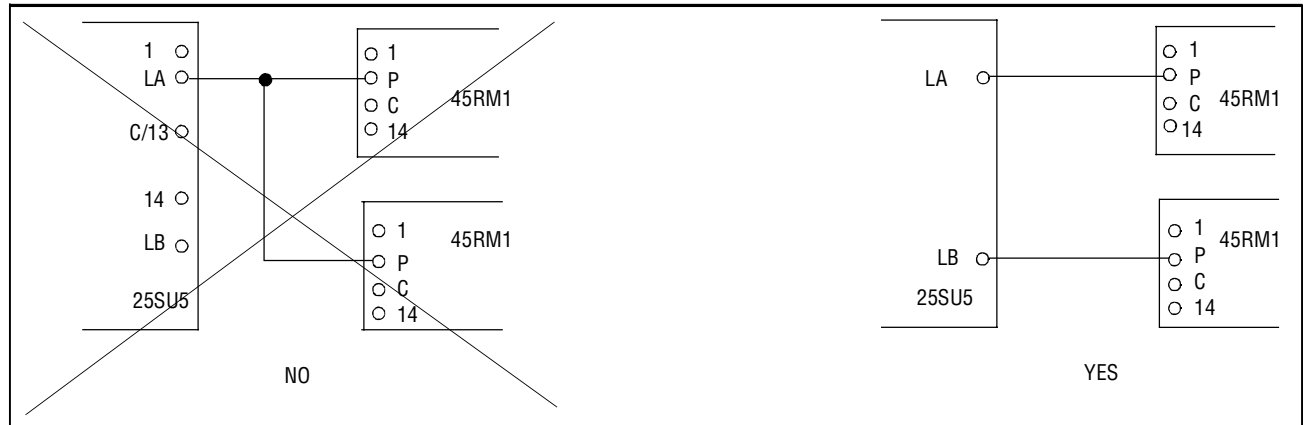
**Note 2:** Scanner cable shield is not shown. Connect cable shield(s) to wiring base terminal C. Refer to appropriate scanner bulletin regarding termination of the shield at the scanner end.



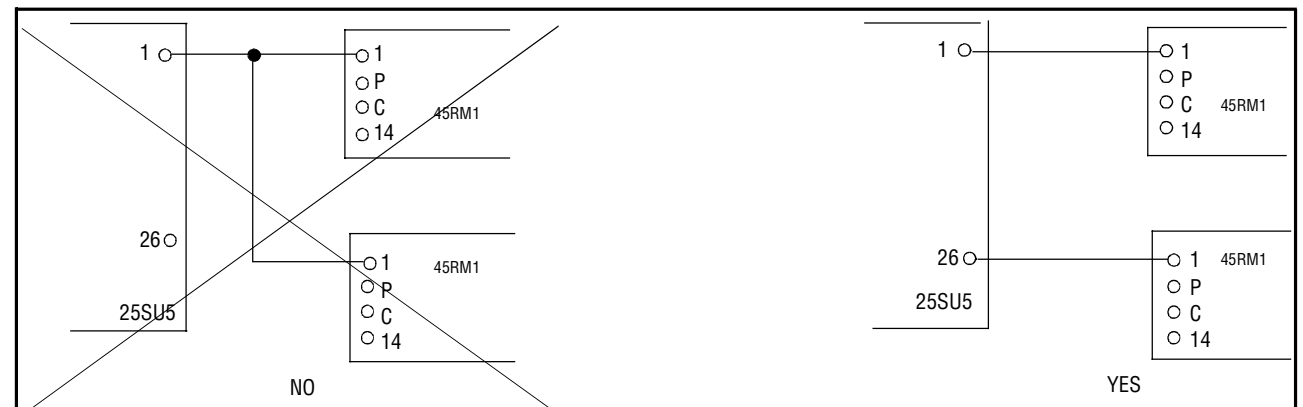
**SCANNER OPERATION**

In all cases shown, the scanners are operative in unison. **The signals from both scanners are combined before passing through the selected sensitivity potentiometer circuits (A or B).** Either scanner will prove the presence of flame by holding the flame relay in if the flame is sufficient.

**Caution: When using line voltage scanners (45RM1, 45RM2 or 45UV5) you cannot power more than one scanner from the same power terminal (LA or LB).**



**Caution: You should never power more than one scanner from a common shutter drive terminal (1 or 26).**





*NOTE: For demonstration purposes, the other necessary connections have been left off the diagrams. It will be necessary to connect all wires (as shown previously) for proper operation.*

**Testing and Adjustment Procedure.**

1. Turn the sensitivity to maximum.
2. Plug a meter into the (+) and (-) test jacks on the Flame Amplifier Module or connect at terminals C/13 (-) and 15 (+), see Figure 7.
3. Establish the flame at the operating level.
4. During aiming of the scanner, it may be helpful to disconnect the shutter drive(s) so there will be a continuous signal. However, this is not a necessity and of course the Flame Relay will drop out.
5. If the meter reading is off scale, decrease the sensitivity until the reading is on scale.
6. Adjust the alignment of the scanner to achieve the highest flame signal strength, usually the first 1/3 of the flame.
7. Turn off the burner being supervised.



8. Verify that the flame signal drops below the flame relay's drop-out threshold, (refer to figure 3), and that the flame relay de-energizes. In multi-burner applications, this test must be performed with the other burners firing.
9. Eliminate any unwanted flame signal by reducing the 25SU5 sensitivity, by re-aligning the scanner, by reducing the scanner's field of view with a sight pipe orifice, or by a combination of these methods.
10. Repeat steps 3 through 9 until reliable operation is achieved.

AGENCY APPROVALS			
TYPE	MODEL	 APPROVED	
25SU5	5011	X	X
	5012	X	X
	5013	X	X
45UV5	1000	X	X
	1010	X	
	1101	X	
45RM1	1001	X	X
	1003	X	
45RM2	1000	X	X
	1001	X	
45RM4	1000	X	X
	1001	X	X
45FS1, 45UVFS1	1000	X	X
	1001	X	X





### Setup and Adjustment with Fireye 45UV5-1000, 1010, 1101 Scanners

U-V Eye Scanners have a UV detector tube that may be placed in one of four different positions. The scanners are shipped with the tube set in the maximum sensitivity position. Aim the scanner at the base of the flame as described in Bulletin CU-22.

### Setup and Adjustment with Fireye 45RM1 and 45RM2 Scanners

BGC scanners have a sensitivity pot located under the screw on the rear of the scanner housing. Turn it clockwise (maximum) and aim at the base of the flame as described in Bulletin CU-26.

### 45RM4-1000, -1001 and 45FS1 / 45UVFS1 -1000, -1001 FLAME SCANNERS

The 45RM4 and 45FS1 Flame Scanners are also compatible with the 25SU5-5011, -5012, -5013 controls. Refer to Bulletins CU-31 and CU-32 for installation instructions for the 45RM4 and 45FS1 respectively. When using a scanner with a programmable flame failure response time (45FS1, 45UVFS1), select 1 second FFRT in the 25SU5 control (see page 5).

## ACCESSORIES

Five Styles of remote analog meters are available for use with the Type 25SU5 Model 5011 Control:

Analog Bar Graph Meter			
Meter Number	Voltage Range	Scale (Flame LEDs)	Meter Dimensions
38-88	0-3V DC	1 to 10	2.2 inches (559) vertical x 1.00 (25.4) inch horizontal. Meter case depth is 3.06 inches (777)
When using 38-88 meter, note the following wiring information:			
Wire Size (AWG)		Length Ft. (m.)	
14		1411 (430)	
16		850 (259)	
18		553 (169)	
20		354 (108)	
22		221 (66)	
24		142 (43)	
3 Conductor twisted shield cable should be used. Shield wire should be connected to GND (Terminal C/13)			
Analog Flame Signal Meters			
Meter Number	Voltage Range	Scale (Flame Units)	Meter Dimensions
38-54	0-3V DC	0 to 64	2 <sup>3</sup> / <sub>8</sub> " (60.3) square
38-55	0-3V DC	0 to 64	1-1/4" (31.8) x 3" (76.2) horizontal
38-56	0-3V DC	0 to 64	3" (76.2) x 1-1/4" (31.8) vertical
38-62	0-3V DC	0 to 64	1/2" (12.7) x 1-5/8" (41.3) horizontal



---

## MAINTENANCE

**Humidity Effects:** It is considered good practice to minimize any possible adverse effects of high humidity by keeping electronic equipment continuously powered, even during periods when it is not in use.

**Scanner:** If continuous air purging of the scanner sight pipe is not completely effective in preventing viewing window contamination, a schedule should be set up for periodically cleaning the window. Always use a soft, clean (non-oily) cloth to wipe the window. For maximum assurance that oily films will be removed, wash first with a cloth dampened (not dripping) with a concentrated detergent solution.

Use original Fireeye repair parts to maintain optimum operation.

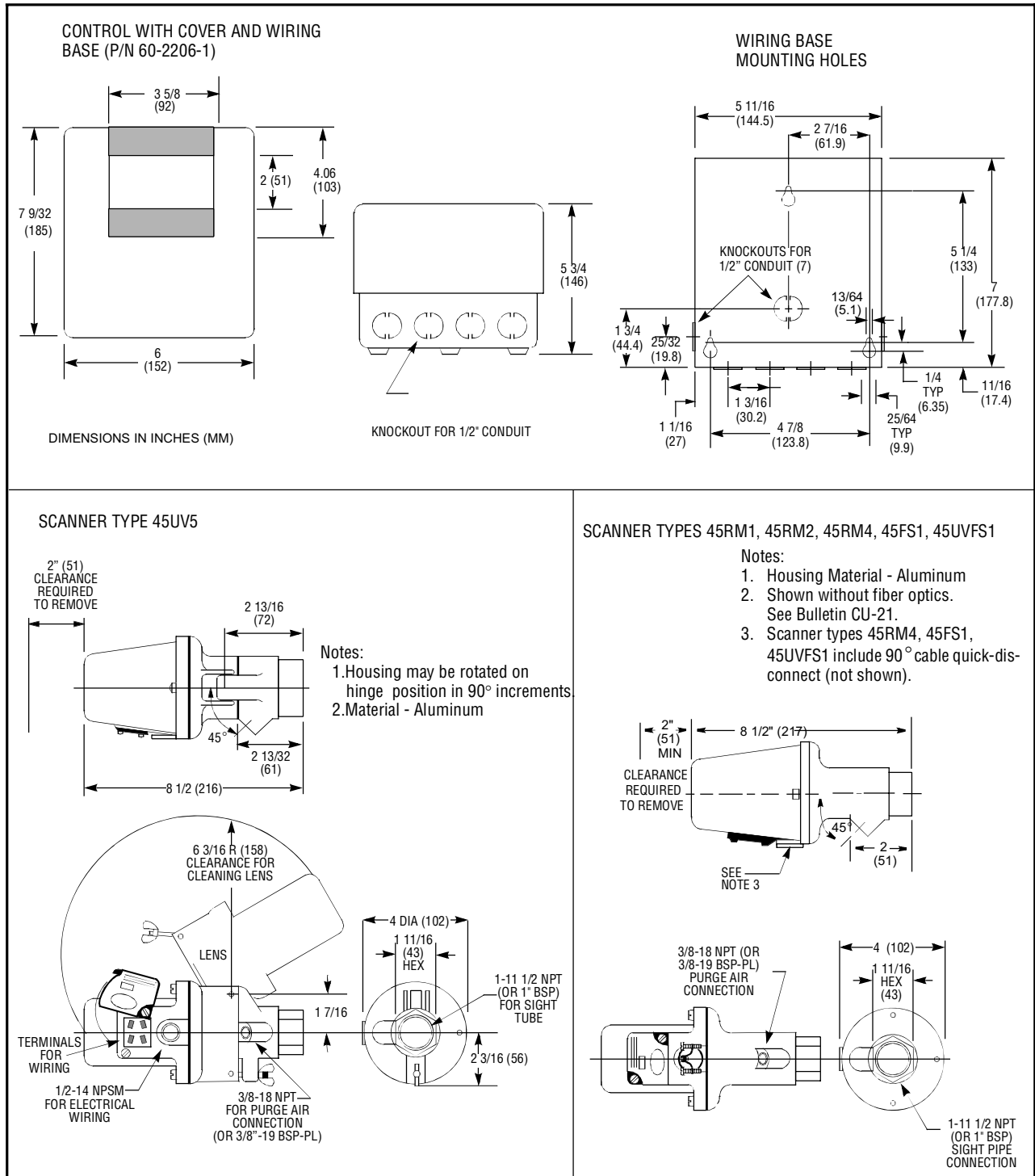


**CAUTION: Disconnect or shut off electric power when working on scanner.**

*Note: When Fireeye products are combined with equipment manufactured by others and/or integrated into systems designed or manufactured by others, Fireeye's warranty, as stated in its General Terms and Conditions of Sale, pertains only to the Fireeye products and not to any other equipment or to the combined system or its overall performance.*



**FIGURE 11. CONTROL, WIRING BASE, AND SCANNER DIMENSIONS**





---

## NOTICE

When Fireeye products are combined with equipment manufactured by others and/or integrated into systems designed or manufactured by others, the Fireeye warranty, as stated in its General Terms and Conditions of Sale, pertains only to the Fireeye products and not to any other equipment or to the combined system or its overall performance.

---

## WARRANTIES

FIREYE guarantees for *one year from the date of installation or 18 months from date of manufacture* of its products to replace, or, at its option, to repair any product or part thereof (except lamps, electronic tubes and photocells) which is found defective in material or workmanship or which otherwise fails to conform to the description of the product on the face of its sales order. **THE FOREGOING IS IN LIEU OF ALL OTHER WARRANTIES AND FIREYE MAKES NO WARRANTY OF MERCHANTABILITY OR ANY OTHER WARRANTY, EXPRESS OR IMPLIED.** Except as specifically stated in these general terms and conditions of sale, remedies with respect to any product or part number manufactured or sold by Fireeye shall be limited exclusively to the right to replacement or repair as above provided. In no event shall Fireeye be liable for consequential or special damages of any nature that may arise in connection with such product or part.



FIREYE®  
3 Manchester Road  
Derry, New Hampshire 03038 USA  
www.fireeye.com

CU-27  
AUGUST 9, 2005  
Supersedes Nov. 2003

