

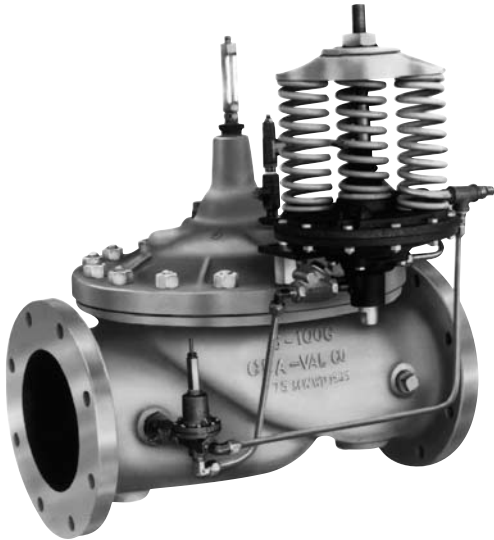

**210-02**  
(Full Internal Port)  
**MODEL**  
**610-02**  
(Reduced Internal Port)  
**Altitude Valve**

**For Two-Way Flow with Delayed Opening**



- **Accurate and Repeatable Level Control**
- **Drip-Tight Positive Shut-Off**
- **Reliable Hydraulic Operation**
- **Easily Adjustable Control**
- **Completely Automatic Operation**

The Cla-Val Model 210-02/610-02 Altitude Valve controls the high water level in reservoirs without the need for floats or other devices. It is a non-throttling valve that remains fully open until the shut-off point is reached. This valve closes at the high water level, and for return flow, delays its opening until the pressure at the valve inlet lowers to a preset adjustable pressure of one to seven pounds.

This valve is hydraulically operated and pilot controlled. The pilot control operates on the differential in forces between a spring load and the water level in the reservoir. When the force of the spring is overcome by the force of the reservoir head, the pilot closes the main valve. The desired high water level is set by adjusting the spring force. The pilot control measures the reservoir head through a customer supplied sensing line\* connected directly to the reservoir.

This valve can also be furnished with auxiliary controls to meet the need for multiple functions, such as: pressure sustaining, pressure reduction, rate of flow control, solenoid override, etc.

**Schematic Diagram**

Item	Description
1	Hytrol (Main Valve)
2	CDS6 Altitude Control
3	X101 Valve Position Indicator
4	Bell Reducer
5	X58A Restriction Assembly
6	CSC Swing Check Valve
7	CVC Flow Check Control
8	CV Flow Control (Closing)

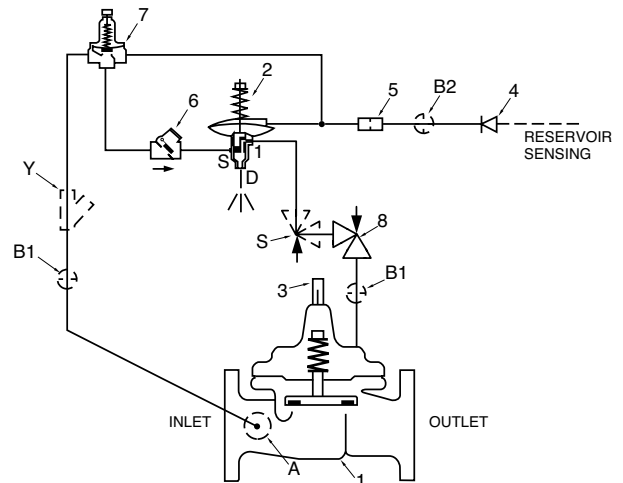

**Optional Features**

Item	Description
A	X46A Flow Clean Strainer
B	CK2 (Isolation Valve)
S	CV Flow Control (Opening)
Y	X43 "Y" Strainer

**Typical Applications**

Used on reservoirs where water is supplied and withdrawn through the altitude valve. The valve closes at the high water level. When pressure at the valve inlet lowers to the desired opening point, the pilot control opens the main valve for return flow to the system. The return flow pressure setting is adjustable to 6 psi below the shut-off pressure. For more information see data sheet E-CDS6.

\*Note: The reservoir pressure sensing line should be 3/4" minimum I.D. installed with a 2° slope from the valve to the reservoir slope to avoid air pockets.

Note: We recommend protecting tubing and valve from freezing temperatures.

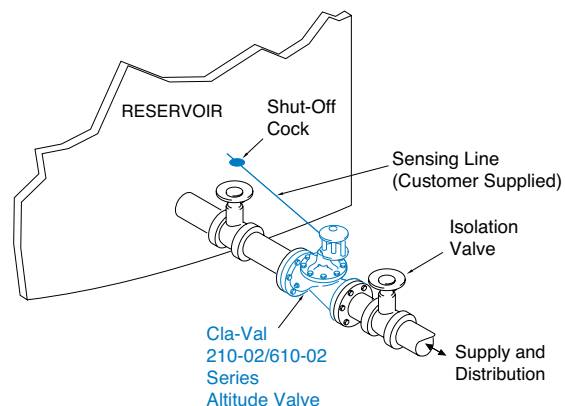

**Model 210-02** (Uses Basic Valve Model 100-01)

**Dimensions**  
(In inches)

**Pressure Ratings** (Recommended Maximum Pressure - psi)

Valve Body & Cover		Pressure Class			
		Flanged		Threaded	
Grade	Material	ANSI Standards*	150 lb.	300 lb.	End** Details
ASTM A536	Ductile Iron	B16.42	250	400	400
ASTM A216-WCB	Cast Steel	B16.5	285	400	400
ASTM B62	Bronze	B16.24	225	400	400

Note: \* ANSI standards are for flange dimensions only.  
Flanged valves are available faced but not drilled.  
\*\* End Details machined to ANSI B2.1 specifications.

**Materials**

Component	Standard Material Combinations		
Body & Cover	Ductile Iron	Cast Steel	Bronze
Available Sizes	2" - 36"	2" - 16"	2" - 16"
Disc Retainer & Diaphragm Washer	Cast Iron	Cast Steel	Bronze
Trim: Disc Guide, Seat & Cover Bearing	Bronze is Standard Stainless Steel is Optional		
Disc	Buna-N® Rubber		
Diaphragm	Nylon Reinforced Buna-N® Rubber		
Stem, Nut & Spring	Stainless Steel		

For material options not listed, consult factory.  
Cla-Val manufactures valves in more than 50 different alloys.

100-01 (Globe)

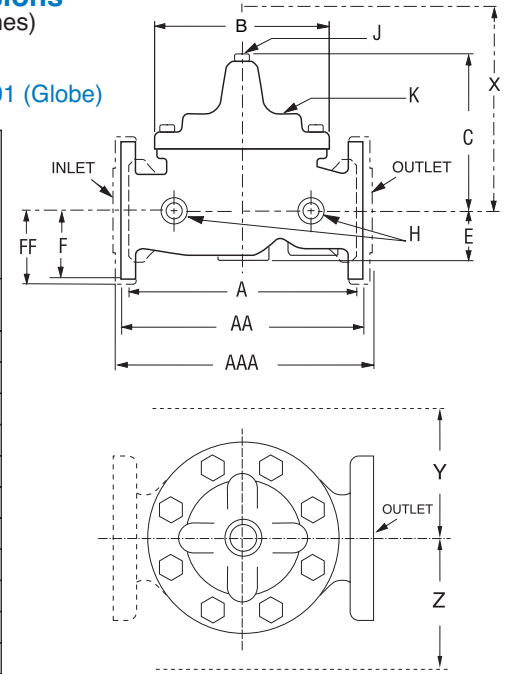

**Cover Capacity**  
Liquid Volume Displaced from Diaphragm Chamber When Valve Opens or Closes

Valve Size	Displacement
2"	.032 gal
2 1/2"	.043 gal
3"	.080 gal
4"	.169 gal
6"	.531 gal
8"	1.26 gal
10"	2.51 gal
12"	4.00 gal
14"	6.50 gal
16"	9.57 gal
24"	29.00 gal
36"	42.00 gal

100-01 (Angle)

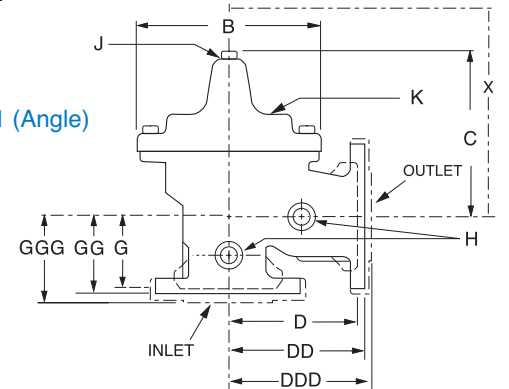

**Model 210-02 Dimensions** (In Inches)

Valve Size (Inches)	2	2 1/2	3	4	6	8	10	12	14	16	24	36
<b>A</b> Threaded	9.38	11.00	12.50	—	—	—	—	—	—	—	—	—
<b>AA</b> 150 ANSI	9.38	11.00	12.00	15.00	20.00	25.38	29.75	34.00	39.00	41.38	61.50	76.00
<b>AAA</b> 300 ANSI	10.00	11.62	13.25	15.62	21.00	26.38	31.12	35.50	40.50	43.50	63.24	78.00
<b>B</b> Dia.	6.62	8.00	9.12	11.50	15.75	20.00	23.62	28.00	32.75	35.50	53.16	66.00
<b>C</b> Max.	6.50	7.56	8.19	10.62	13.38	16.00	17.12	20.88	24.19	25.00	43.93	61.50
<b>D</b> Threaded	4.75	5.50	6.25	—	—	—	—	—	—	—	—	—
<b>DD</b> 150 ANSI	4.75	5.50	6.00	7.50	10.00	12.75	14.88	17.00	19.50	20.81	—	—
<b>DDD</b> 300 ANSI	5.00	5.88	6.38	7.88	10.50	13.25	15.56	17.75	20.25	21.62	—	—
<b>E</b>	1.50	1.69	2.56	3.19	4.31	5.31	9.25	10.75	12.62	15.50	17.75	24.56
<b>F</b> 150 ANSI	3.00	3.50	3.75	4.50	5.50	6.75	8.00	9.50	10.50	11.75	19.25	28.00
<b>FF</b> 300 ANSI	3.25	3.75	4.13	5.00	6.25	7.50	8.75	10.25	11.50	12.75	—	—
<b>G</b> Threaded	3.25	4.00	4.50	—	—	—	—	—	—	—	—	—
<b>GG</b> 150 ANSI	3.25	4.00	4.00	5.00	6.00	8.00	8.62	13.75	14.88	15.69	—	—
<b>GGG</b> 300 ANSI	3.50	4.31	4.38	5.31	6.50	8.50	9.31	14.50	15.62	16.50	—	—
<b>H</b> NPT Body Tapping	3/8	1/2	1/2	3/4	3/4	1	1	1	1	1	1	2
<b>J</b> NPT Cover Center Plug	1/2	1/2	1/2	3/4	3/4	1	1	1 1/4	1 1/2	2	1 1/2	2
<b>K</b> NPT Cover Tapping	3/8	1/2	1/2	3/4	3/4	1	1	1	1	1	1	2
Valve Stem Internal Thread UNF	10-32	10-32	1/4-28	1/4-28	3/8-24	3/8-24	3/8-24	3/8-24	3/8-24	3/8-24	1/2-20	3/4-16
Stem Travel	0.6	0.7	0.8	1.1	1.7	2.3	2.8	3.4	4.0	4.5	6.75	10.12
Approx. Ship Wt. Lbs.	35	50	70	140	285	500	780	1165	1600	2265	6200	11470
<b>X</b> Pilot System	13.00	14.00	15.00	17.00	29.00	31.00	33.00	36.00	40.00	40.00	68.00	86.00
<b>Y</b> Pilot System	9.00	10.00	11.00	12.00	20.00	22.00	24.00	26.00	29.00	30.00	39.00	45.00
<b>Z</b> Pilot System	9.00	10.00	11.00	12.00	20.00	22.00	24.00	26.00	29.00	30.00	39.00	45.00

## Model 610-02 (Uses Basic Valve Model 100-20)

## Dimensions (In inches)

### Pressure Ratings (Recommended Maximum Pressure - psi)

Valve Body & Cover		Pressure Class		
		Flanged		
Grade	Material	ANSI Standards*	150 lb.	300 lb.
ASTM A536	Ductile Iron	B16.42	250	400
ASTM A216-WCB	Cast Steel	B16.5	285	400
ASTM B62	Bronze	B16.24	225	400

Note: \*ANSI standards are for flange dimensions only. Flanged valves are available faced but not drilled.

### 100-20 (Globe)

#### Cover Capacity

Liquid Volume Displaced from Diaphragm Chamber When Valve Opens or Closes

Valve Size	Displacement
3"	.032 gal
4"	.080 gal
6"	.169 gal
8"	.531 gal
10"	1.26 gal
12"	2.51 gal
14"	2.51 gal
16"	4.00 gal
18"	4.00 gal
20"	9.57 gal
24"	9.57 gal
30"	29.00 gal

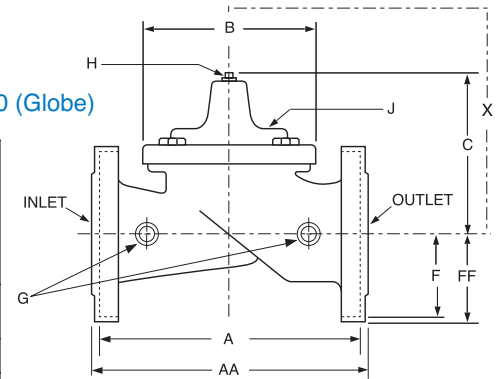

### Materials

Component	Standard Material Combinations		
Body & Cover	Ductile Iron	Cast Steel	Bronze
Available Sizes	3" - 48"	3" - 16"	3" - 16"
Disc Retainer & Diaphragm Washer	Cast Iron	Cast Steel	Bronze
Trim: Disc Guide, Seat & Cover Bearing	Bronze is Standard Stainless Steel is Optional		
Disc	Buna-N® Rubber		
Diaphragm	Nylon Reinforced Buna-N® Rubber		
Stem, Nut & Spring	Stainless Steel		

For material options not listed, consult factory.  
Cla-Val manufactures valves in more than 50 different alloys.

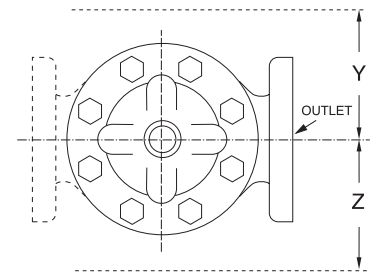



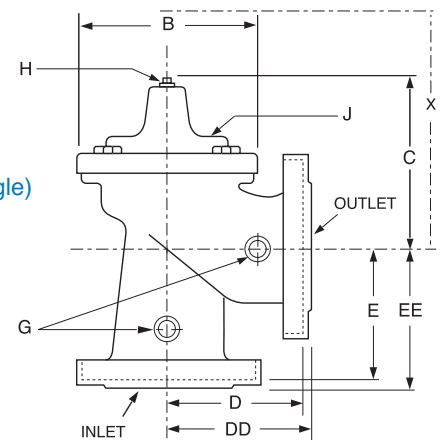



































### 100-20 (Angle)



### Model 610-02 Dimensions (In Inches)

Valve Size (Inches)	3	4	6	8	10	12	14	16	18	20	24	30
A 150 ANSI	10.25	13.88	17.75	21.38	26.00	30.00	34.25	35.00	42.12	48.00	48.00	63.25
AA 300 ANSI	11.00	14.50	18.62	22.38	27.38	31.50	—	36.62	43.63	49.62	49.75	—
B Dia.	6.62	9.12	11.50	15.75	20.00	23.62	28.00	28.00	35.44	35.44	35.44	53.19
C Max.	7.00	8.62	11.62	15.00	17.88	21.00	20.88	25.75	25.00	31.00	31.00	43.94
D 150 ANSI	—	6.94	8.88	10.69	—	—	—	—	—	—	—	—
DD 300 ANSI	—	7.25	9.38	11.19	—	—	—	—	—	—	—	—
E 150 ANSI	—	5.50	6.75	7.25	—	—	—	—	—	—	—	—
EE 300 ANSI	—	5.81	7.25	7.75	—	—	—	—	—	—	—	—
F 150 ANSI	3.75	4.50	5.50	6.75	8.00	9.50	11.00	11.75	15.88	14.56	17.00	19.88
FF 300 ANSI	4.12	5.00	6.25	7.50	8.75	10.25	—	12.75	15.88	16.06	19.00	—
H NPT Body Tapping	3/8	1/2	3/4	3/4	1	1	1	1	1	1	1	1
J NPT Cover Center Plug	1/2	1/2	3/4	3/4	1	1	1 1/4	1 1/4	2	2	2	2
K NPT Cover Tapping	3/8	1/2	3/4	3/4	1	1	1	1	1	1	1	1
Valve Stem Internal Thread UNF	10-32	1/4-28	1/4-28	3/8-24	3/8-24	3/8-24	3/8-24	3/8-24	1/2-20	1/2-20	1/2-20	3/4-16
Stem Travel	0.6	0.8	1.1	1.7	2.3	2.8	3.4	3.4	3.4	4.5	4.5	6.5
Approx. Ship Wt. Lbs.	45	85	195	330	625	900	1250	1380	1500	2551	2733	6500
X Pilot System	13.00	15.00	27.00	30.00	33.00	36.00	36.00	41.00	40.00	46.00	55.00	68.00
Y Pilot System	10.00	11.00	18.00	20.00	22.00	24.00	26.00	26.00	30.00	30.00	30.00	39.00
Z Pilot System	10.00	11.00	18.00	20.00	22.00	24.00	26.00	26.00	30.00	30.00	30.00	39.00

Valve Selection		These Symbols  and  Indicate Available Sizes																	
		Inches	1 ¼	1 ½	2	2 ½	3	4	6	8	10	12	14	16	18	20	24	30	
		mm	32	40	50	65	80	100	150	200	250	300	350	400	450	500	600	750	
		End Detail	Threaded	Threaded & Flanged					Flanged										
Model 210-02	Basic Valve 100-00	Globe																	
		Angle																	
	Suggested Flow (GPM)	Max. Continuous			210	300	460	800	1800	3100	4900	7000	8400	11000				25000	
		Max. Intermittent			260	370	580	990	2250	3900	6150	8720	10540	13700				31300	
	Suggested Flow (Liters/Sec)	Max. Continuous			13	19	29	50	113	195	309	441	529	693				1575	
		Max. Intermittent			16.4	23	37	62	142	246	387	549	664	863				1972	
Model 610-02	Basic Valve 100-20	Globe																	
		Angle																	
	Suggested Flow (GPM)	Max. Continuous					260	580	1025	2300	4100	6400	9230	9230	16500	16500	16500	28000	
		Max. Intermittent					16	37	65	145	258	403	581	581	1040	1040	1040	1764	

**610-02 is the reduced internal port size version of the 210-02.**

For 100-01 basic valves, suggested flow calculations were based on flow through Schedule 40 Pipe. Maximum continuous flow is approx. 20 ft/sec (6.1 meters/sec) & maximum intermittent is approx. 25 ft /sec (7.6 meters/sec). For 100-20 basic valves, suggested flow calculations were based on flow through the valve seat. Approx. 26 ft/sec (7.9 meters/sec) is used for maximum continuous flow. Maximum continuous flow through the valve seat for the valve seat for the 30" 100-20 is approx. 20 ft/sec (6.1 meters/sec).

\*\*Flanged End Detail Only

### Pilot System Specifications

**Adjustment Ranges**

- 5 - 40 ft.
- 30 - 80 ft.
- 70 - 120 ft.
- 110 - 160 ft.
- 150 - 200 ft.

**Temperature Range**

Water: to 180°F

If flowing line pressure is less than 10 psi, consult factory for full details.  
If inlet pressure is above 150 psi, consult factory for recommendations.

**Materials**

Standard Pilot System Materials

- Pilot Control: Bronze ASTM B62
- Trim: Stainless Steel Type 303
- Rubber: Buna-N® Synthetic Rubber

Optional Pilot System Materials

- Pilot Systems are available with optional Aluminum, Stainless Steel or Monel materials at additional cost.
- Valve position indicator is standard.

### When Ordering, Please Specify

1. Catalog No. 210-02 or No. 610-02
2. Valve Size
3. Pattern - Globe or Angle
4. Pressure Class
5. Threaded or Flanged
6. Materials Desired
7. Adjustment Range
8. Desired Options
9. When Vertically Installed



Distributed By:  
M&M Control Service, INC.  
Phone: 800-876-0036  
Fax: 847-356-0747  
Email: Sales@mmcontrol.com