



## DESCRIPTION AND INSTALLATION

**For 45UV5 UV self-checking Scanner Models:**

**45UV5-1005, 45UV5-1006,  
45UV5-1007, 45UV5-1008,  
45UV5-1009 and 45UV5-1105**

**For use only with designated Fireye® controls**

**For Infrared Photocell Scanners use SC103**

**For non self-checking UV Scanners use SC102**



### IMPORTANT NOTE

The information provided in this bulletin is directed to competent boiler and combustion service technicians who are experienced in the installation and operation of Fireye Flame Safety equipment. Persons not familiar with Fireye products should contact the nearest Fireye representative or other qualified service group.

The 45UV5 scanners as well as all other Fireye scanners, are designed to be used exclusively with the appropriate Fireye Flame Safeguard and Burner Management controls. The application of these scanners to other than Fireye equipment should be reviewed for approval by Fireye.

### APPLICATION

Fireye 45UV5 self-checking scanners are used to detect ultraviolet emissions from fossil fuel flames such as natural gas, coke oven gas, propane, methane, butane, kerosene, light petroleum distillates and diesel fuels.

These 45UV5 models are used only with the Flame-Monitor, BurnerLogix, D-Series, FlameWorx, MicroM and some P-Series Fireye control models to provide flame safeguard and monitoring systems for supervised manual, semi-automatic and fully automatic single burner boilers, process ovens and heaters.

### PRINCIPLES OF OPERATION

The 45UV5 scanners use a UV-eye detector. This detector is a sealed, gas filled, UV-sensitive tube containing two electrodes connected to a source of AC voltage. When UV radiation of sufficient energy falls upon the electrodes, electrons are released and the inter-electrode gas becomes conductive, resulting in an electric current flow from one electrode to the other. The current flow starts and ends abruptly and is known as an "avalanche."

A very intense source of UV radiation will produce several hundred avalanches or pulses per second. With less radiation there will be fewer pulses per second. Upon total disappearance of flame, the detector output ceases. Thus, the presence or absence of pulses is an indication of the presence or



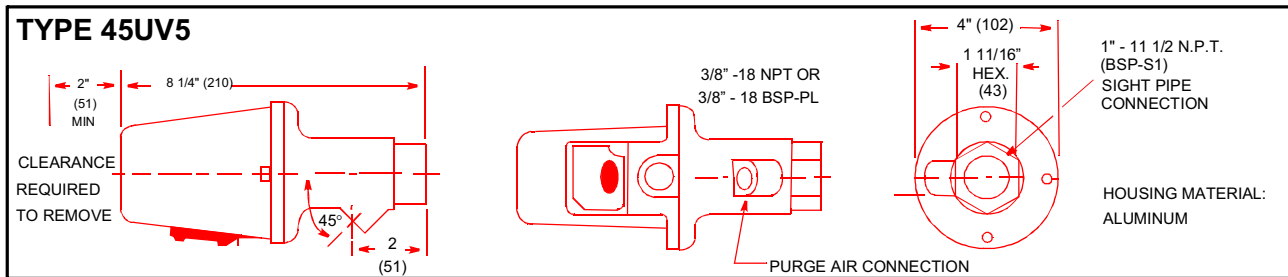
absence of flame; the frequency of the pulses is a measure of flame intensity. Pulses generated by the scanner are transmitted to a compatible Fireye control via scanner wiring.

## FEATURES

The components are contained in a cast aluminum housing sealed with an oil-resistant gasket. The quartz lens is a planoconvex design, resulting in increased sensitivity. Also included in the scanner is an electromagnetic shutter that permits a self-checking circuit to verify that the scanner and signal circuits are producing valid flame presence or absence information. During the shutter closed period, the detector's optical path is blocked from flame radiation, allowing the amplifier control to verify the proper operation of the ultraviolet tube. While the shutter is open, flame presence or absence is detected. The resultant scanner output (while flame is detected) is a continuous, periodically interrupted, pulsed flame signal which is a prerequisite for energizing the associated Fireye control's Flame Relay.

## SPECIFICATIONS

FIGURE 1.



## SPECIFICATIONS TABLE

MODEL NO.	THREADS	NOMINAL SHUTTER TOTAL CYCLE PERIOD	VOLTAGE 50/60 HZ		TEMP. RANGE		USE ONLY WITH CONTROL MODELS	TERMINALS	
			SHUTTER (BLK)	SIGNAL (RED)	MAX.	MIN.		SIGNAL	SHUTTER
45UV5-1005	1" NPT	Regulated by control	17 VDC	560 VAC	200° F (93° C)	- 40° F (- 40° C)	25RU8-4580 25SU5-4013/4113 -4113T/4116T -4116/4119 -4018 •See note 4 •See note 1, but must use 61-5745-3 to control shutter	12 & 13 All Models	14 & 15 All Models
45UV5-1105	1" BSP			560VAC					
45UV5-1006	1" NPT	1.4 sec. closed 3.5 sec. open	120 VAC	560 VAC	200° F (93° C)  See Note 6	- 40° F (- 40° C)	D-Series 72DUVS1 Only	S1-S2	L1-L2
45UV5-1007	1" BSP	.4 sec. closed 3.6 sec. open	230 VAC	560 VAC		- 40° F (- 40° C)	See note 1	S1-S2 See note 3	L1-L2
45UV5-1008	1" BSP	.4 sec. closed 3.6 sec. open	120 VAC	560 VAC		- 40° F (- 40° C)	See note 1	S1-S2 See note 3	L1-L2
45UV5-1009	1" NPT	.4 sec. closed 3.6 sec. open	120VAC	560VAC		- 40° F (- 40° C)	See note 1	S1-S2 See note 3	L1-L2

**NOTE 1:** Flame-Monitor, EUVS4; D-Series, 72DUVS1T, 72DUVS4; MicroM, MEUVS1, MEUVS4; FlameWorx; MBUVS-301D, MBUVS-311D, BurnerLogix, YB110UVSC.

**NOTE 2:** Models 1006, 1007, 1008 and 1009 have shutter drive circuitry within the scanner. Models 1005 and 1105 have shutter drive circuitry in compatible control.

**NOTE 3:** When using FlameWorx modules, MBUVS-301D and MBUV-311D, refer to bulletin FWX-1001 for proper wiring terminals.

**NOTE 4:** Controls no longer manufactured.

**NOTE 5:** 45-1005 and 45-1105 are NOT FM approved for use with 25RU8-4580, 25SU5-4013/4113-4113T/4116T-4116/4119.

**NOTE 6:** Extended temperature range applies to engineering code 3 and higher.

**Housing Material:** Cast aluminum

**Weight:** 7 lbs. (3.2 kg)

**Housing Dimensions:** See Fig. 1

**Purge Air:** 4 SCFM (113L/min) at 3/8 inch threaded housing inlet or 4 SCFM at 1 inch wye fitting in scanner sight pipe. Temperatures near the upper limit of the scanner operating range and/or use with dirty duels may require up to 15 SCFM (425 L/min.).

**Optical Range:** 2200 to 2600 angstroms. No response to infrared radiation or visible light.

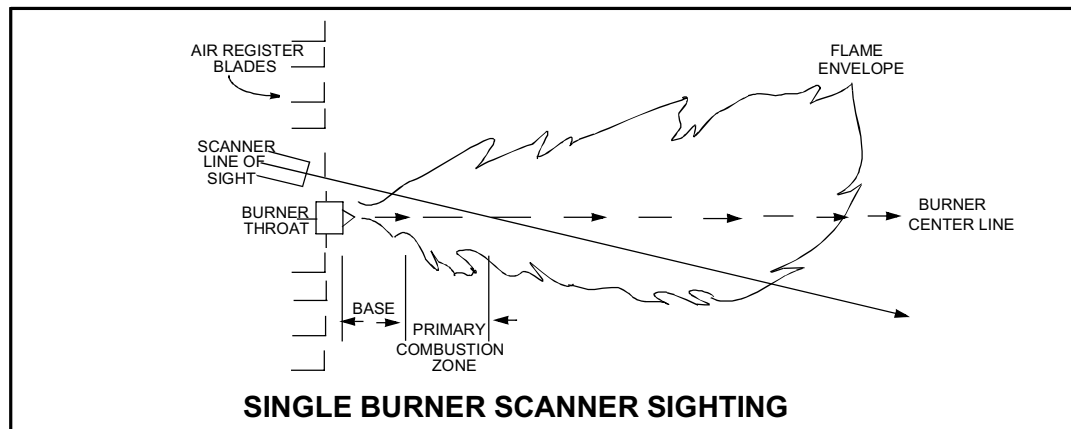
**Optical Field of View:** 1 inch per foot (25.4mm/305mm)

**Operating Range:** 72 inches (1830mm) or less.

## INSTALLATION

The best scanner sighting results are obtained when the scanner is aimed so that its line of sight intersects the burner center line at a slight angle, as shown in Figure 2. The area of maximum ultraviolet radiation is near the base of the flame envelope. When only one scanner is used per burner, the intersection should be made so the line of sight or viewing angle can also see the pilot flame. Consideration must be given to burner secondary air rotation (some burners have clockwise air rotation and others counter-clockwise). Figure 3 illustrates how scanner location is influenced by the pilot positions and secondary air circulation. Physical obstructions such as air register blades should not fall in the line of sight of the scanner.

FIGURE 2.

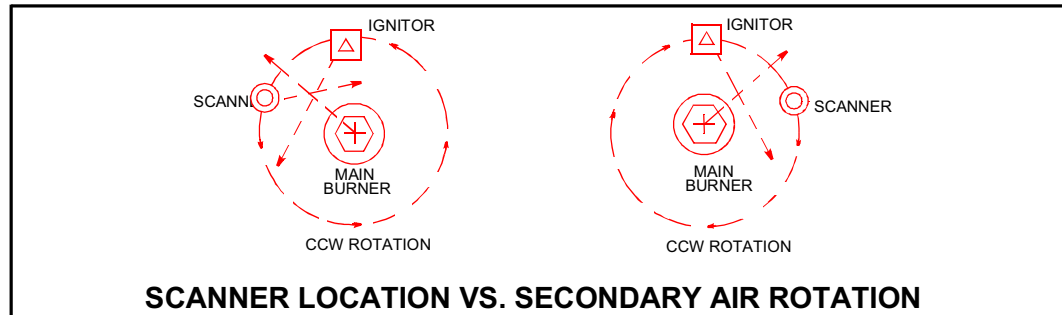


1. AN ACCEPTABLE SCANNER LOCATION MUST ENSURE THE FOLLOWING:
  - Reliable pilot flame detection.
  - Reliable main flame detection.
  - Rejection of pilot flame too short or in the wrong position to ignite the main flame reliably, thus prohibiting main fuel admission.

*NOTE: Reliable signals must be obtained at all air flows and furnace loads (ranges of fuel firing).*



FIGURE 3.



2. If combustion air enters the furnace with a rotational movement of sufficient velocity to deflect pilot flame in direction of rotation, position the scanner 0 to 30 degrees downstream of the pilot burner and close to the periphery of the throat where the ultraviolet radiation is at a maximum. (See Figures 2 and 3).
3. Having determined an appropriate location for the sight tube, cut a clearance hole for a 2 inch pipe through the burner plate. If register vanes interfere with the desired line of sight, the interfering vane(s) should be trimmed to assure an unobstructed viewing path at all firing levels, see Figure 4.
4. Mount scanner sight pipe by either:
  - Centering a Fireeye No. 60-1664-3 (NPT) or 60-1664-4 (BSP) swivel mount over the hole and installing the sight pipe on the swivel mount,
  - or**
  - Inserting the end of the sight pipe into the hole, aligning the pipe to the desired viewing angle and tack welding. (Welding must be adequate to temporarily support the weight of the installed scanner). The sight pipe should be arranged to slant downward so that the dirt and dust will not collect in it.

FIGURE 4.



5. When a satisfactory sighting position has been confirmed by operational test, (see section on alignment), the sight pipe should either be firmly welded in place or, if the swivel mount is used, the base position should be secured by tightening the three hex head cap screw located on the swivel mount ring. In certain older style swivel mounts, tack welding may be required.
6. Excessive flame signal can affect flame discrimination and prevent the control connected to the scanner from performing properly. To reduce the signal level of the tube, or improve flame discrimination, orifices may be installed to decrease the scanner's field of view and reduce its sensitivity. Installation of the orifice disk is shown in Figure 6.
7. The scanner viewing window must be kept free of contaminants (oil, smoke, soot, dirt) and the scanner temperature must not exceed its maximum rating. Both requirements will be satisfied by continuous injection of purge air.

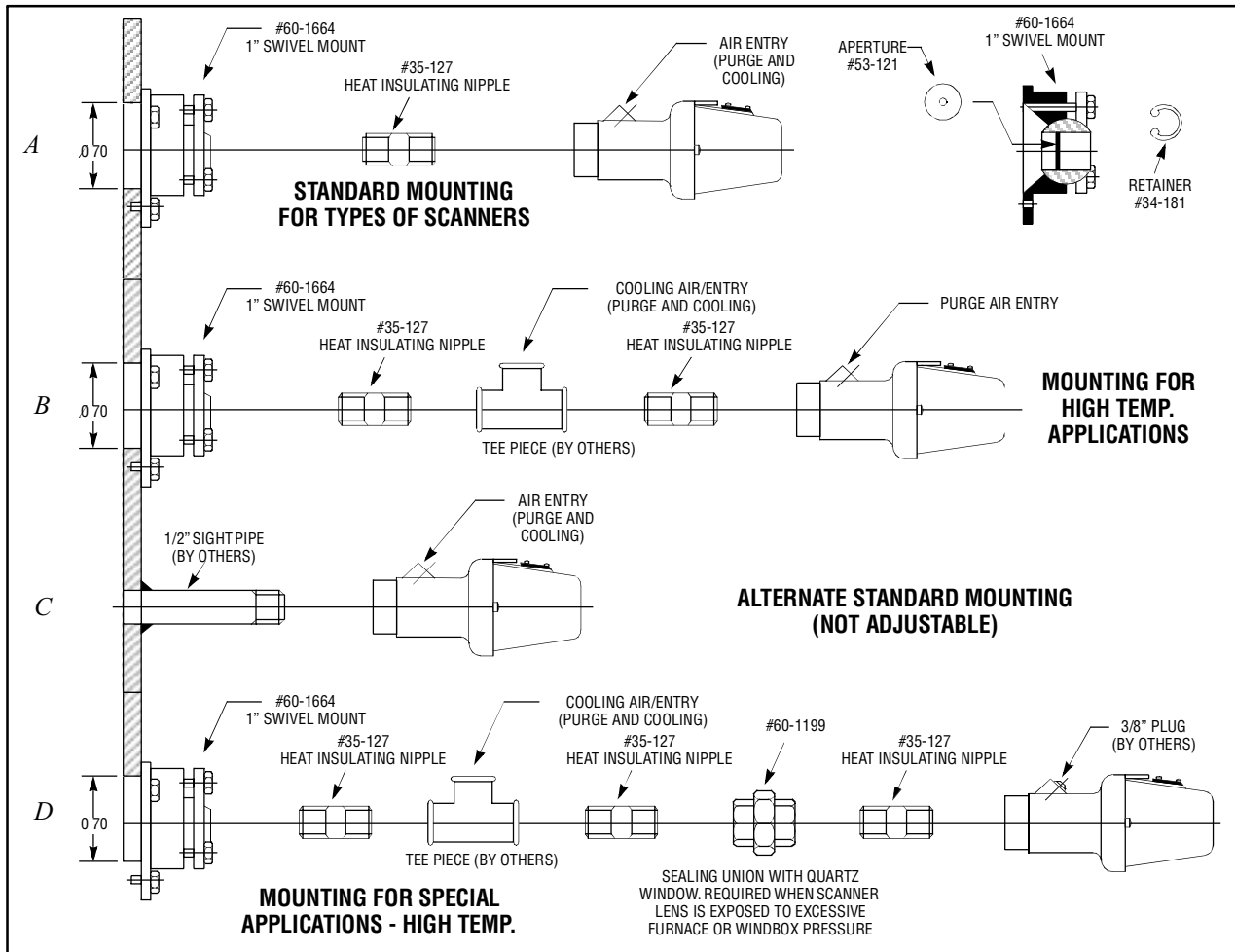
The scanner mounting may be made with provision for purge air through the 3/8" opening as shown in Figure 5, Item A or C, or through a 1" tee/wye connection as shown in Figure 5, Item B. Normally only one of the two connections is provided with purge air and the other is plugged. When a Fireeye union is used as shown in Figure 5, the 1" tee/wye connection is used for the purge air (plug 3/8" opening).



Under normal temperature conditions, with clean burning fuels and moderate ambient temperature conditions, purge air flow of approximately 4 SCFM (113 L/min) is generally adequate. A 0.1 psig positive pressure difference between the atmosphere and boiler pressure measured at right angle to the purge air flow, should result in a purge air flow of 4 SCFM. Up to 15 SCFM (425 L/min) may be required for fuels that may produce high levels of smoke or soot or for hot environments to maintain scanner internal temperature within specifications.

*NOTE: The maximum viewing field of the lens is one inch per foot. Do not use more than one foot of one inch sight pipe. Increase sight pipe diameter one inch for every additional foot of sight pipe length used, to avoid restricting the scanner's field of view. Temperature in the scanner housing should not exceed those temperature limits listed in the specifications. Excessive temperatures will shorten scanner life.*

**FIGURE 5.**



**SCANNER WIRING**

All FIREYE controls are protected against short-circuited scanner input terminals. Following recommendations apply for scanner-control wiring: The following recommendations apply for scanner control wiring:

- Keep scanner wiring as short as possible.
- Use wires rated for scanner voltage and its ambient conditions (temperature, humidity, oil resistant, flame retardant, etc.)
- Do not run scanner wires in the same conduit as other electrical wires.

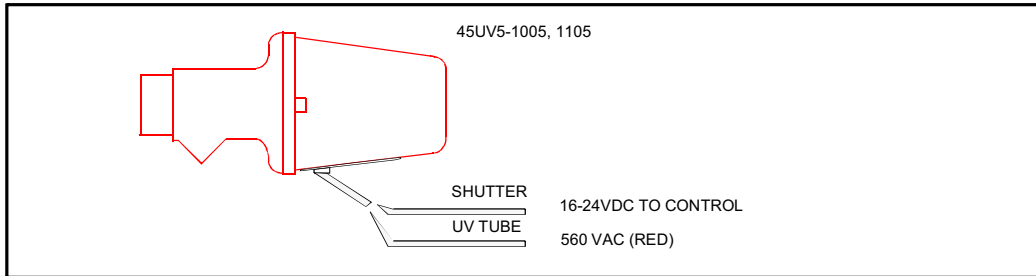


- Avoid wire loops and poor groundings.
- Keep high voltage ignition wires well away from scanner wires.

The 45UV5 self-check scanner has four 6 foot (1800mm) leads:

#### 45UV5-1005 & 1105:

Two black leads which power the shutter from the associated control and two red leads which drive the UV tube and carry the flame signal to the control amplifier.



#### 45UV5-1006, 1007, 1008 & 1009:

Two black leads which power the shutter via L1 & L2 and two red leads which drive the UV tube and carry the flame signal to S1 & S2 on the control.

If it is necessary to extend the scanner wiring, the following instructions apply:

Scanner wires should be installed in a separate conduit. The wires from several scanners may be installed in a common conduit.

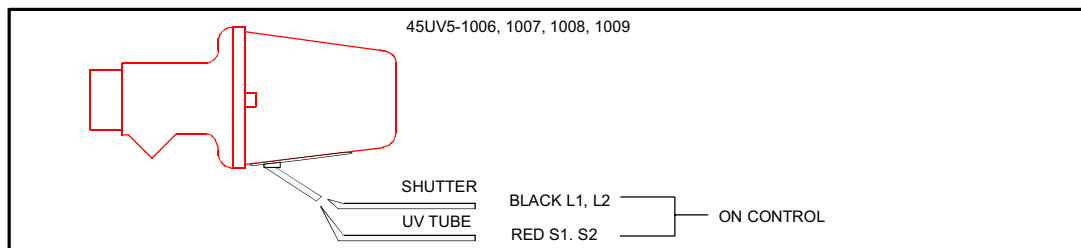
#### 45UV5-1006, 1007, 1008, 1009.

##### 1. Selection of wire

- Use #14, 16, or 18 wire with 75 C, 600 volt insulation for up to 100 foot distances (signal loss approximately 20% at 100 feet).
- Asbestos insulated wire should be avoided.
- Multiconductor cable is not recommended without prior factory approval.
- **Extended Scanner Wiring.** For extended scanner wiring up to 1500 feet, and for shorter lengths to reduce signal loss, use a shielded wire (Belden 8254-RG62U) coaxial cable, or equal **for each red wire** of the 45UV5. The ends of the shielding must be taped individually on both ends and not grounded.

For multiple burner installations:

- Distances are decreased when more than one set of scanner leads are installed in a common conduit. For example, the maximum distance for 2 scanners is 750 feet and for 3 or more scanners the distance decreases to 500 feet.
- High voltage ignition wiring should not be installed in the same conduit with flame detector wires.



**WARNING: DO NOT CONNECT 45UV5 SCANNERS IN PARALLEL**

**45UV5-1005, 1105**

1. Up to 25 foot conduit run.
  - Use #18 AWG or heavier, 600V 90C minimum rated wire, installed in conduit.
2. Over 25 to 300 feet maximum:
  - Use #18 AWG or heavier, 600v, 75C rated wire for the two black leads (shutter).
  - **Extended Scanner Wiring.** For extended scanner wiring up to 1500 feet, and for shorter lengths to reduce signal loss, use a shielded wire (Belden 8254-RG62U) coaxial cable, or equal **for each red wire** of the 45UV5. The ends of the shielding must be taped individually on both ends and not grounded.

For multiple burner installations:

3. Distances are decreased when more than one set of scanner leads are installed in a common conduit. For example, the maximum distance for 2 scanners is 750 feet and for 3 or more scanners the distance decreases to 500 feet.
4. High voltage ignition wiring should not be installed in the same conduit with flame detector wires.

---

**ALIGNMENT AND ADJUSTMENTS**

The following procedures are recommended to ensure optimum flame detection and discrimination. Flame discrimination is the ability to see only one burner or one pilot with other burners or pilots operating nearby. These procedures should be used whenever parts are replaced, when the scanner has been moved, when the flame shape is altered (additional fuels, new burners, burner/register modifications) as well as on all new installations.

**Pilot Flame Scanner**

1. Apply power to scanner and associated control.
2. Start pilot.
3. Adjust scanner sighting to detect pilot flame in the manner shown in Figure 4.
4. When flame is properly sighted, the flame signal should correspond to the acceptable ranges indicated in the appropriate bulletin for each compatible FIREYE control. If readings fluctuate widely, readjust scanner sighting until highest, steadiest reading is obtained.
5. When the proper signal reading has been obtained, make sure that the scanner and the associated control do not respond to the ignition spark. This is accomplished by cutting off the fuel to the pilot and attempting to start the pilot using the spark igniter. If the system responds to the spark, the sighting should be realigned.

**Main Flame Scanner**

1. Apply power to scanner and associated control.
2. Start pilot.
3. Adjust scanner sighting so that ignition spark and pilot flame are not detected. Test should be conducted with maximum pilot flame and with both minimum and maximum airflow.
4. Start main burner.
5. Adjust scanner sighting to detect main burner flame. When sighting is correct (see above), the signal should be read in the acceptable range for the control in use, without extreme fluctuations.
6. When proper signal is established, manually close off the main burner fuel supply. When burner flame becomes unstable or is extinguished, the control should register a “flame failure” condition.
7. Start an adjacent burner and vary its firing rate under normal airflow conditions. Make certain that the main flame scanner on the burner not in service does not respond to adjacent burner flame. Readjust sighting if necessary.



**CAUTION: Minimum pilot is the minimum flame required to satisfactorily ignite the main burner. Be sure to test for reliable signals under maximum airflow conditions when the pilot**



### SWIVEL MOUNT

The scanner swivel mount Part No. 60-1664-4 (BSP) 60-1664-3 (NPT) is used to adjust the scanner sighting angle after the scanner has been installed. The swivel mount is used as indicated the figures in this document.

### Orifices

The Orifice restricts the field of view (target area), reduces air flow, maintains air flow, maintain air block, and increases discrimination between flame and background radiation. The orifice is secured within the ball of a swivel mount with an orifice retainer or the orifice can be placed within a one inch union (not provided).

The scanner should ideally sight a target area of 4 to 25 square inches (25-150 cm<sup>2</sup>) of the flame front. The flame front is a plane within the combustion space separating the region of unburned fuel from the burning fuel.

*Note: There is an inverse relationship between discrimination and sensitivity.*

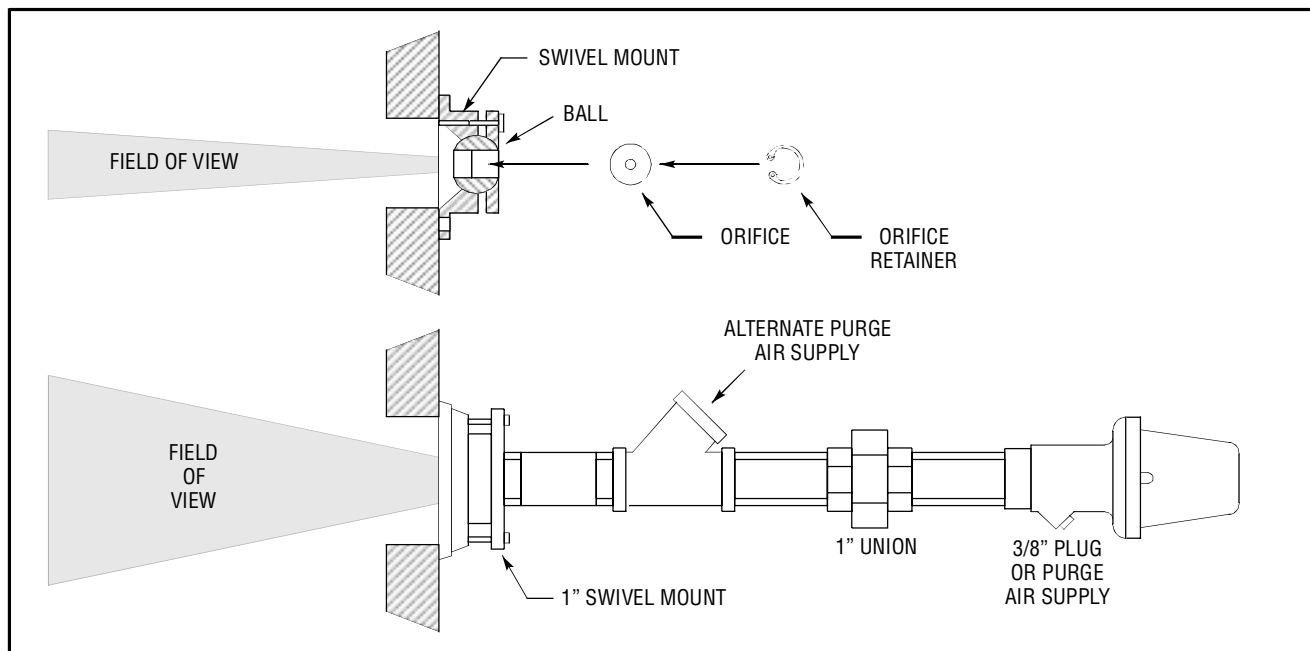
### Heat Insulating Nipple

The heat insulating nipple Part No. 35-127-3 (BSP); 35-127-1 (NPT) prevents heat transfer from the hot sight pipe to the scanner head.

### Sealing Union with Quartz Window

The sealing union (60-1199) is used whenever a union or seal is required for scanner piping. The size is one inch US standard taper pipe thread (1" NPT). The sealing union has a quartz window to block off the scanner from the furnace pressure and heat. When the sealing union is used, the 1" tee/wye is used for the purge air inlet. Be sure the quartz window is properly seated to seal off the scanner. Do not over-tighten union collar because damage to the window may result. For best results, hand tighten union collar.

FIGURE 6.



## MAINTENANCE

1. The control and scanner should be powered at all times (except for repair, cleaning or replacement) to reduce any harmful effects of atmospheric humidity.





2. The scanner and sight pipe must be kept clean to prevent overheating and assure optical qualities.
3. When replacing or cleaning the UV tube, note the position of the tube pins. They are mounted on a rectangular base so that the tube can only be inserted into the socket with the electrodes broadside to the shutter window.



**CAUTION: DISCONNECT OR SHUT OFF ELECTRIC POWER WHEN WORKING ON SCANNER.**

4. Clean the quartz lens and tube with glass detergent or glass cleaning agents which contain no abrasives. After cleaning, remove all cleaning films with a soft lint-free cloth. (Some cleaning films may reduce or filter UV.)
5. Use original FIREYE parts to maintain optimum operation. Recommended spare parts:

Part Number	Description
4-314-1`	UV Tube
61-2913	Shutter Assembly with Lens
29-248	Flange Gasket
82-95	Lens Holder
46-38	Lens
92-48	Quartz window (Part of Union 60-1199)

FIREYE original equipment factory replacement parts are available at various sub-assembly levels.

## TROUBLESHOOTING THE UV SELF-CHECKING SCANNER

The UV self-checking scanner is a fail-safe device. If you are having a problem, make sure that you are supplying proper voltage to the scanner tube and shutter.

- The two red leads to the tube from the control should be approximately 560 VAC.
  - The two black leads from the control to the shutter should be a pulsating 16-24 volt signal for the 45UV5-1005 and 45UV5-1105 or line voltage for other 45UV5 models. If A or B is a problem, replace the control or control amplifier. There are two failure modes of the UV self-check scanner.
1. UV tube failure
  2. Shutter failure.
- Either of these failures will prevent the burner from operating.

## IF THE TUBE HAS FAILED

1. In a semi-automatic FIREYE control (70D40 or FlameWorx) the system will not start if the tube indicates flame when no flame is present. (Safe start check). Solution — replace UV tube only.
2. In an automatic FIREYE control 70D10, 70D20, 70D30, FLAME-MONITOR and MicroM control, the control will lockout on safety (during the prepurge) if the tube indicates flame with no flame present (Safe start check) “False Flame Purge” shown on FLAME-MONITOR control. Solution — Replace UV tube only.
3. In all systems if the scanner does not indicate the presence of flame (DC voltage on flame meter) with the scanner looking at the pilot flame or a source of ultra-violet radiation (lighter or propane torch) replace the UV tube.

## IF THE SHUTTER HAS FAILED

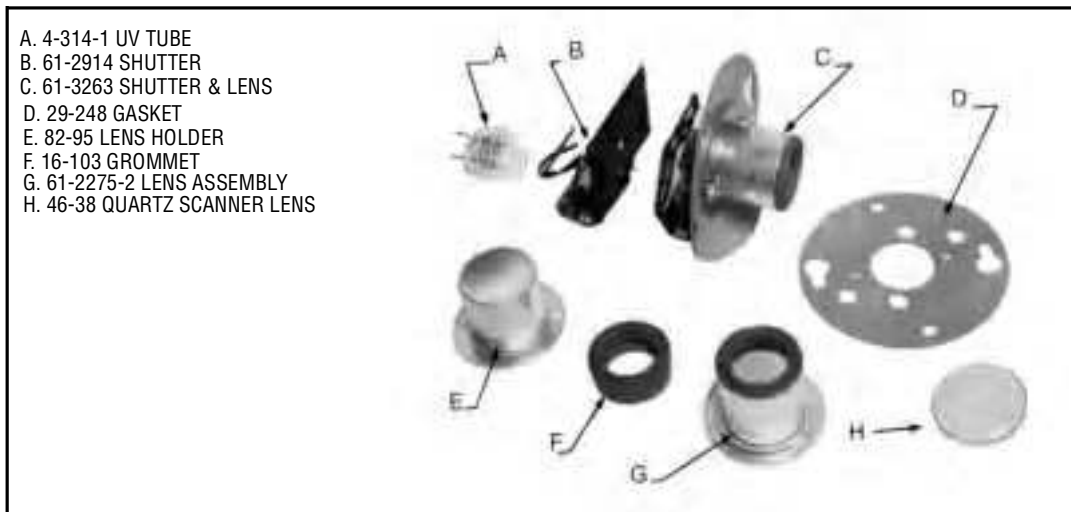
In all systems during the pilot trial-for-ignition period the system will shut down and lockout if the shutter has failed to close or open. Solution — save UV tube — replace scanner. Visual checks can be made to detect shutter malfunction.

## PART NUMBERS AND ACCESSORIES

FIGURE 7.

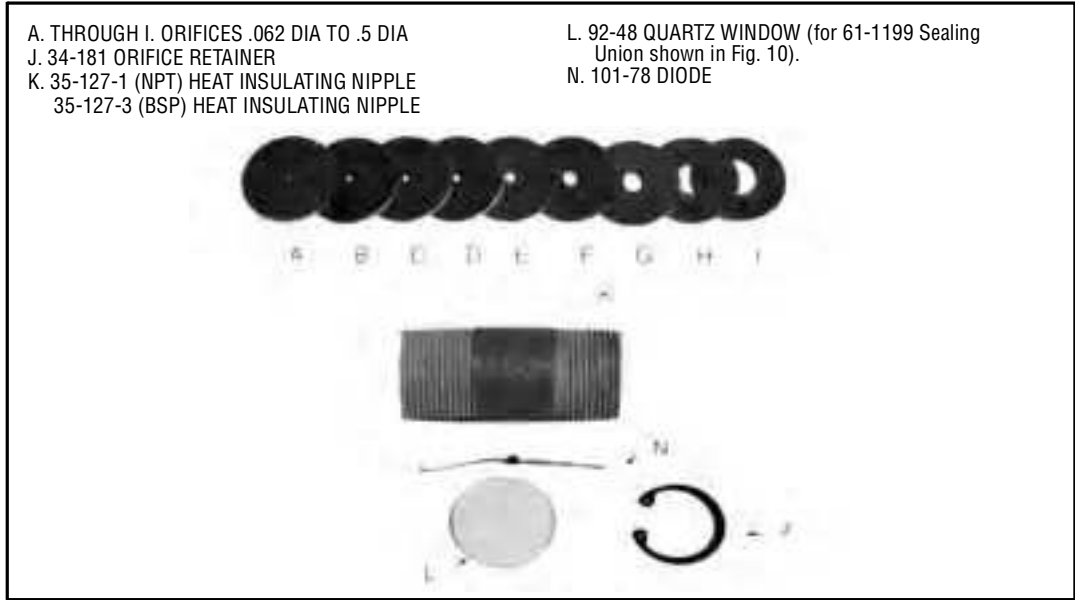


FIGURE 8.





**FIGURE 9.**



**FIGURE 10.**



**ACCESSORIES**

FIGURE	PART NUMBER	DESCRIPTION
9A	52-121-2	Orifice .062" Diameter
9B	53-121-3	Orifice .078" Diameter
9C	53-121-4	Orifice .093" Diameter
9D	53-121-5	Orifice .109" Diameter
9E	53-121-6	Orifice .125" Diameter
9F	53-121-7	Orifice .187" Diameter
9G	53-121-8	Orifice .250" Diameter
9H	53-121-9	Orifice .375" Diameter
9I	53-121-10	Orifice .50" Diameter
	35-200	1" Wye
	35-201	1" Close Nipple



---

## NOTICE

When Fireeye products are combined with equipment manufactured by others and/or integrated into systems designed or manufactured by others, the Fireeye warranty, as stated in its General Terms and Conditions of Sale, pertains only to the Fireeye products and not to any other equipment or to the combined system or its overall performance.

---

## WARRANTIES

FIREYE guarantees for *one year from the date of installation or 18 months from date of manufacture* of its products to replace, or, at its option, to repair any product or part thereof (except lamps, electronic tubes and photocells) which is found defective in material or workmanship or which otherwise fails to conform to the description of the product on the face of its sales order. **THE FOREGOING IS IN LIEU OF ALL OTHER WARRANTIES AND FIREYE MAKES NO WARRANTY OF MERCHANTABILITY OR ANY OTHER WARRANTY, EXPRESS OR IMPLIED.** Except as specifically stated in these general terms and conditions of sale, remedies with respect to any product or part number manufactured or sold by Fireeye shall be limited exclusively to the right to replacement or repair as above provided. In no event shall Fireeye be liable for consequential or special damages of any nature that may arise in connection with such product or part.



FIREYE  
3 Manchester Road  
Derry, New Hampshire 03038 USA  
www.fireeye.com

SC-101  
JULY 18, 2005  
(Supersedes March 28, 2005)

