

# Controllers & Transmitters

## Table of Contents

PRODUCT	PRODUCT CODE	RESOURCE DOCUMENTS	PAGE #
<b>Pneumatic Receiver-Controllers</b>			
Single Input Receiver-Controller	RC 195	155-119P25	C-3
Multiple Input Receiver-Controller	RC 195	155-036P25	C-5
<b>Pneumatic Transmitters</b>			
Temperature Transmitters	TT 184	155-077P25	C-7
Room and Duct Humidity Transmitters	HT 186	155-026P25	C-9
Low Differential Pressure Transmitters	PT 141	155-035P25	C-11
<b>Pneumatic Receiver Gauges</b>			
Receiver Gauges	GA 142A	155-023P25	C-15
<b>Pneumatic Regulators/Controllers</b>			
Static Pressure and Liquid Level Regulators	PR 269	155-033P25	C-17
<b>Accessories and Service Kits</b>			C-19

C-1

Controllers &amp; Transmitters

# Single Input Receiver-Controller

## RETROLINE®

easily replaces:

- Barber-Coleman
- Johnson Controls
- Honeywell
- Robertshaw
- Seibe



195 Single Input Receiver-Controller.

## Description

The 195 Single Input Receiver-Controller is a pneumatic controller which receives one pneumatic input, and produces a pneumatic output signal based on the net pneumatic input and the mechanical settings of the setpoint and percent proportional band. This controller can be easily changed from direct to reverse acting.

Retroline Receiver-Controller (195-1000) includes decals and installation instructions to replace competitive models.

## Features

- Rugged proven design
- Plug-in air connections for ease of installation, calibration, and service
- Internal restrictors for transmitter inputs
- Stick-on scales included for setpoint dial in standard transmitter ranges
- Large, easy-to-read scales on all adjustments
- Calibration card for converting transmitter range to 3 to 15 psi (21 to 103 kPa) signal
- Tamper-resistant cover

## Options

- Retroline products for replacing competitive products
- Pressure Gauge (order separately, see page C-21)

## Applications

The 195 Single Input Receiver-Controller is a one-input, direct/reverse acting instrument used to control temperatures, humidity, and pressure of mechanical equipment in commercial and industrial facilities.

### Typical Connections

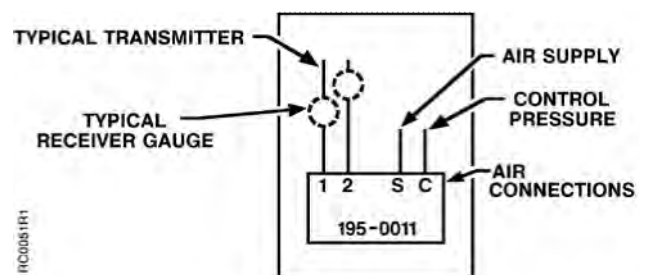

## 195 Specifications

**Action**  
 Input #1 ..... Direct  
 Input #2 ..... Reverse

**Pneumatic Inputs** ..... 3 to 15 psi (21 to 103 kPa)

**Control Output** ..... 0 psi (0 kPa) to supply pressure 22 psi (152 kPa)

**Operating Ambient Temperature Range** ..... 40 to 120°F (4 to 49°C)

**Supply Pressure**  
 Operating..... 22 psi (152 kPa)  
 Maximum Safe ..... 30 psi (207 kPa)

**% Proportional Band Adjustment Range** ..... 2 to 20% for a 5 psi (34 kPa) control pressure change

**Air Consumption** ..... 60 scim (17 ml/s), *not including transmitters*

**Air Capacity** ..... 2 psi (14 kPa) Pressure Change at 9 psi (62 kPa) control pressure  
 Supply ..... 640 scim (175 ml/s)  
 Exhaust ..... 590 scim (161 ml/s)

**Mounting** ..... Surface

**Air Connections**  
 Barb fittings for 1/4" (6 mm) OD polyethylene tubing. Two plug-in connectors are provided; one for the direct acting and the reverse acting transmitter inputs and one for supply and control lines. 1/8" NPT connection provided for control pressure gauge (gauge not included).

**Case Material** ..... Lexan, 20% glass-filled

**Dimensions** ..... 6.75" W x 5.69" H x 3.5" D (171 mm W x 144 mm H x 89 mm D)

**Shipping Weight** ..... 3.1 lb. (1.4 kg)

## 195 Product Ordering

Description	Part No.
Single Input Receiver-Controller	<b>195-0011</b>

### RETROLINE®

Manufacturer	Manufacturer Part No.	Part No. <sup>1</sup>
Barber-Coleman	RKS-1001	<b>195-1000</b>
Barber-Coleman	RKS-2001	<b>195-1000</b>
Barber-Coleman	RKS-5001	<b>195-1000</b>
Honeywell	RP908A	<b>195-1000</b>
Honeywell	RP920A	<b>195-1000</b>
Johnson Controls	T-5800-1	<b>195-1000</b>

#### Ordering Note

- Includes **195-0011** plus decals to replace any competitive single input receiver-controller.

C-4

Controllers & Transmitters

Accessories & Service Kits

C-19

# Multiple Input Receiver-Controller

## RETROLINE®

easily replaces:

- Barber-Coleman
- Johnson Controls
- Honeywell
- Robertshaw
- Seibe



195 Multiple Input Receiver-Controller with Control Pressure Gauge.

## Description

The 195 Multiple Input Receiver-Controller is a pneumatic controller that receives up to three pneumatic inputs and produces a pneumatic output signal based on the net pneumatic input and the setpoint, percent proportional band, and authority settings. The Controller can be easily changed from direct to reverse acting.

Retroline Receiver-Controller (195-1000) includes decals and installation instructions to replace competitive models.

## Features

- Rugged proven design
- Plug-in air connections for ease of installation, calibration, and service
- Internal restrictors for transmitter inputs
- Stick-on scales included for setpoint dial in standard transmitter ranges
- Large, easy-to-read scales on all adjustments
- Calibration card for converting transmitter range to 3 to 15 psi (21 to 103 kPa) signal
- 0 to 30 psi (0 to 200 kPa) Pressure Gauge
- Retroline products for replacing competitive products

## Applications

The 195 Multiple Input Receiver-Controller is commonly used when the setpoint needs to be automatically reset based on a separate input; can also be used as a single input device.

*Example:* Change hot water supply temperature setpoint based on outside air temperature.

## Typical Connections

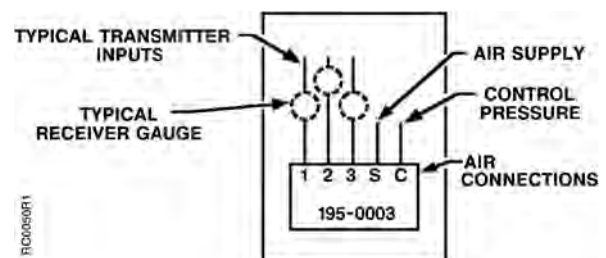

## 195 Specifications

### Action

Input #1 ..... Direct  
 Input #2 ..... Reverse

### Reset

Input #3 ..... Direct reset relative to Input #2  
 Reverse reset relative to Input #1

**Pneumatic Inputs** ..... 3 to 15 psi (21 to 103 kPa)

**Control Output** ..... 0 psi (0 kPa) to supply pressure 22 psi (152 kPa)

### Operating Ambient

**Temperature Range** ..... 40 to 120°F (4 to 49°C)

### Supply Pressure

Operating..... 22 psi (152 kPa)  
 Maximum Safe ..... 30 psi (207 kPa)

### % Proportional Band

**Adjustment Range** ..... 2 to 20% for a 5 psi (34 kPa) control pressure change

**% Authority Adjustment Range** ..... 20 to 200%

**Air Consumption** ..... 60 scim (17 ml/s), *not including transmitters*

**Air Capacity** ..... @ 2 psi (14 kPa) Pressure Change and 9 psi (62 kPa) control pressure

Supply ..... 640 scim (175 ml/s)  
 Exhaust ..... 590 scim (161 ml/s)

**Mounting** ..... Surface, vertical

### Air Connections

Barb fittings for 1/4" (6 mm) OD polyethylene tubing. Two plug-in connectors are provided; one for the three transmitter inputs and one for supply and control lines. 1/8" NPT connection provided for control pressure gauge.

**Case Material** ..... Lexan, 20% glass-filled

**Dimensions** ..... 6.75" W x 5.69" H x 3.5" D  
 (171 mm W x 144 mm H x 89 mm D)

**Shipping Weight** ..... 3.1 lb. (1.4 kg)

## 195 Product Ordering

Description	Part No.
Multiple Input Receiver-Controller	195-0003

### RETROLINE®

Manufacturer	Manufacturer Part No.	Part No. <sup>1</sup>
Barber-Coleman	RKS-3002	195-2000
Barber-Coleman	RKS-4002	195-2000
Johnson Controls	T-5800-3	195-2000
Robertshaw	P-341	195-2000
Robertshaw	P-541	195-2000
Honeywell	RP908B	195-2000
Honeywell	RP920B	195-2000

### Ordering Note

- Includes 195-0003 plus decals to replace competitive receiver-controllers.

## Accessories & Service Kits

C-19

## Dimensions/Engineering Drawings

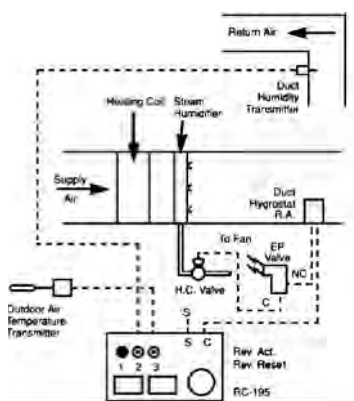

Humidity Control

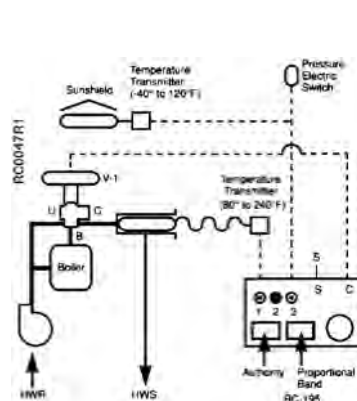

Temperature Control

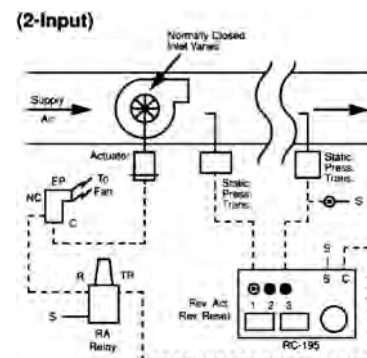

Static Pressure Control

# Temperature Transmitters

## RETROLINE®

easily replaces:

- Barber-Coleman
- Johnson Controls
- Honeywell
- Robertshaw
- Seibe



## Description

The 184 Temperature Transmitters are direct acting, one-pipe instruments that sense temperature and transmit a proportional 3 to 15 psi (21 to 103 kPa) pneumatic signal to a remotely located receiver gauge and/or receiver controller. Temperature Transmitters operate on the force-balance principle, using internal feedback for excellent linearity and accuracy.

Retroline transmitters easily replace any competitive model. Refer to the appropriate product to locate the Retroline replacement.

## Features

- 1-pipe, direct acting
- Rapid response to temperature changes over their full range
- Available in a variety of sensing elements and temperature ranges
- Available with rigid bulb, remote averaging bulb, and room transmitter
- Internal feedback for excellent linearity and accuracy

## Applications

The 184 Temperature Transmitters can be used for a variety of applications to monitor temperature and are ideal for those requiring indication with a receiver-controller.

### Application Drawing

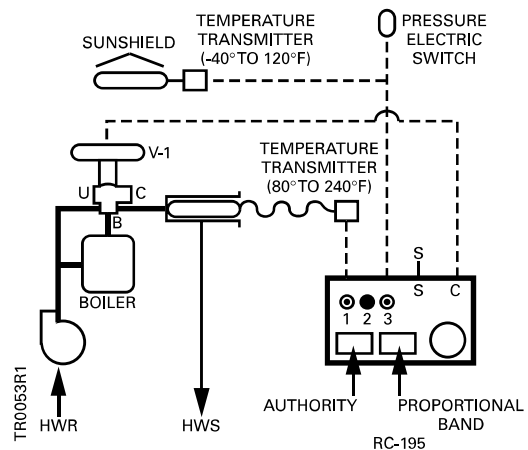

Hot water temperature setpoint reset.

C-7

Controllers & Transmitters

## Retroline® 184 Temperature Transmitters Specifications

**Action** ..... Direct

**Output Air Pressure** ..... 3 to 15 psi (21 to 103 kPa)

**Ambient Temperature Range** ..... 40 to 120°F (4.4 to 49°C)

**Input (supply) Air Pressure**

Restrictor Size ..... 40 scim (11 ml/s)

Calibration Pressure ..... 22± 1.0 psi (152± 6.9 kPa)

Maximum ..... 30 psi (207 kPa)

**Thermal System**

Room ..... Bimetal

Rigid Bulb ..... Rod and tube

Remote Bulb ..... Liquid-filled

**Air Consumption** ..... 35 scim (10 ml/s)

**Air Connections** ..... 1/8" NPT (Except for room type)

**Mounting**

Room ..... Wall terminal

Rigid Bulb ..... Mounting flange

Remote Bulb ..... Mounting flange or well bracket mounting kit

Averaging Bulb ..... Mounting flange

**Cover Finish**

Room ..... Desert Beige, plastic

Rigid, Averaging and Remote Bulb ..... Gray

**Dimensions**

Room ..... 2.16" W x 3.35" H x 1.59" D  
(55 mm W x 85 mm H x 40 mm D)

Averaging Bulb/Remote Bulb ..... 1.875" W x 3" H x 1.69" D  
(48 mm W x 76 mm H x 33 mm D)

**Shipping Weights**

Room ..... 0.83 lb. (0.38 kg)

Rigid Bulb ..... 1.5 lb. (0.68 kg)

Remote Bulb ..... 2.0 lb. (0.91 kg)

Averaging Bulb with Armored Capillary ..... 3.0 lb. (1.36 kg)

Averaging Bulb ..... 2.0 lb. (0.91 kg)

## RETROLINE® Product Ordering

Manufacturer Part No.	Description	Temperature Range	Part No.
<b>Honeywell</b>			
LP914A1003	<b>Rigid Bulb Transmitter</b> 12" bulb (255 mm)	-40 to +160°F (-40 to +371°C)	<b>184-0120</b>
LP914A1052	<b>Rigid Bulb Transmitter</b> 6" bulb (152 mm)	40 to 240°F (4 to 116°C)	<b>184-0121</b>
TP974A2000	<b>Room Temperature Transmitter</b>	50 to 100°F (10 to 38°C)	<b>184-0126</b>
T5002-201	<b>Room Temperature Transmitter</b>	50 to 100°F (10 to 38°C)	<b>184-0127</b>
<b>Johnson Controls</b>			
T5210-1002	<b>Remote Bulb Transmitter</b> 1/4" x 7-5/8" bulb (6.4 mm x 194 mm) w/ 8" (203 mm) capillary	0 to 100°F (-18 to 38°C)	<b>184-0123</b>
T5210-1004	<b>Remote Bulb Transmitter</b> 1/4" x 7-5/8" bulb (6 mm x 194 mm) w/ 8" (203 mm) capillary	40 to 240°F (4 to 116°C)	<b>184-0122</b>
T5210-1007	<b>Averaging Bulb Transmitter</b> 3/32" x 18-3/4" bulb 2.4 mm x 5.7 m) w/ 12" (0.305 m) capillary	50 to 150°F (10 to 38°C)	<b>184-0129</b>
T5210-1009	<b>Averaging Bulb Transmitter</b> 3/32" x 18-3/4" bulb (2 mm x 5.7 m) w/ 12" (0.305 m) capillary	0 to 100°F (-18 to +38°C)	<b>184-0125</b>
T5210-1113	<b>Remote Bulb Transmitter</b> 1/4" x 7-5/8" bulb (6 mm x 194 mm) w/ 50" (1.27 m) capillary	-40 to +160°F (-40 to +71°C)	<b>184-0124</b>
<b>Robertshaw</b>			
2220-053	<b>Room Temperature Transmitter</b>	50 to 90°F (10 to 32°C)	<b>184-0128</b>

C-8

Controllers & Transmitters

### Accessories & Service Kits C-19

# Room and Duct Humidity Transmitters



186-0043 Room Humidity Transmitter.



186-0089 Duct Humidity Transmitter.

## Description

The 186 Room and Duct Transmitters are one-pipe, direct acting pneumatic instruments that sense space humidity and transmit a 3 to 15 psi (21 to 103 kPa) pneumatic signal to a remote receiver gauge and/or receiver-controller to read percent relative humidity.

## Features

- Inorganic sensing element for rapid response to humidity changes
- Bimetal temperature compensation minimizes temperature effects
- Cover included with Room Transmitter
- Available for room mounting (vertical) and duct mounting that is at least 6-inches (152 mm) high and 6-1/2-inches (165 mm) deep

## Applications

The 186 Room and Duct Humidity Transmitters operate on a force-balance principle with internal feedback to obtain linearity to accurately sense relative humidity.

The transmitter output can be sent to a receiver-controller for control of an air conditioning or process control system

## Recommendation

**Room:** Air velocity must be at least 30 FPM (0.15m/s) and the transmitter should be located where it senses actual *room conditions* (away from doors, equipment, etc.).

**Duct:** Duct transmitters should be used whenever possible in the return air duct.

## Application Drawing

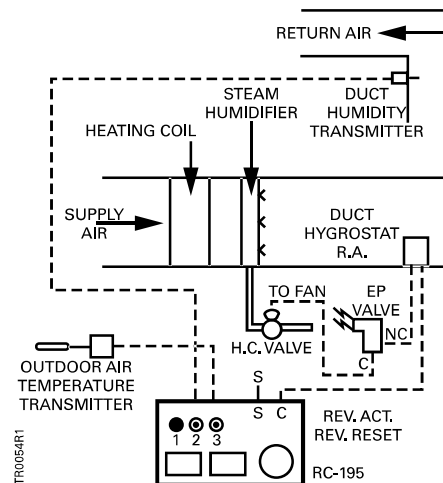

Typical Application of Return Air Duct



## 186 Humidity Transmitters Specifications

**Action** ..... Direct  
**RH Range** ..... 20 to 80% RH  
**Maximum Operating Temperature** ..... 135°F (57°C)  
**Supply Pressure**  
 Maximum..... 30 psi (207 kPa)  
 Normal Operating..... 22± 1.0 psi (152± 6.89 kPa)  
**Effect of 10°F (5.6°C)**  
**Temperature Change** ..... Shift of 1% RH  
**Air Consumption** ..... 35 scim (9.6 ml/s)  
**Output Pressure** ..... 3 to 15 psi (21 to 103kPa)  
**Air Connections** ..... 1/8" (3 mm)

### Mounting

Room..... Wall terminal  
 Duct ..... Duct at least 6" H x 6.5" D  
 (152 mm H x 165 mm D)

**Standard Room Cover Finish** ..... Desert Beige, plastic

### Duct Box

Material..... Galvanized Steel

**Air Connections** ..... 1/4" (6 mm) barbed connection

### Dimensions

Room..... 2.06" W x 3.19" H x 1.37 D  
 (53 mm W x 81 mm H x 35 mm D)

Duct..... 4.5" W x 5.87" W x 6" D  
 (114 mm W x 149 mm W x 152 mm D)

### Shipping Weights

Room..... 0.84 lb. (0.38 kg)  
 Duct..... 3.14 lb. (1.42 kg)

## 186 Humidity Transmitters Product Ordering

Description	Part No.
Duct Humidity Transmitter	<b>186-0089</b>
Room Humidity Transmitter	<b>186-0043</b>

C-10

Controllers & Transmitters

# Low Differential Pressure Transmitters



141 Low Differential Pressure Transmitter.

## Description

The 141 Low Differential Pressure Transmitter is a compact, direct acting, one-pipe device that converts a differential pressure input into a proportional air signal. The input can be either static or velocity pressure differentials of a positive or negative type.

## Features

- 1-pipe
- Two input ports (HI and LO)
- One supply pressure port (SIG)
- Rugged construction

## Applications

The 141 Low Differential Pressure Transmitter operates on the force-balance principal and can be used to indicate and/or control static or velocity differential pressures in ducts, across fans, coils, filters, and between any two reference points; can also indicate velocity pressure in duct work. The output signal can be sent to a remotely located, receiver-controller, receiver gauge, and/or sensitive switching pneumatic relay and pressure switch.

## Recommendation

Use both of the HI and LO ports for differential pressure applications; either the HI or LO port can be used for static pressure applications.

C-11

Controllers & Transmitters

### Application Drawing

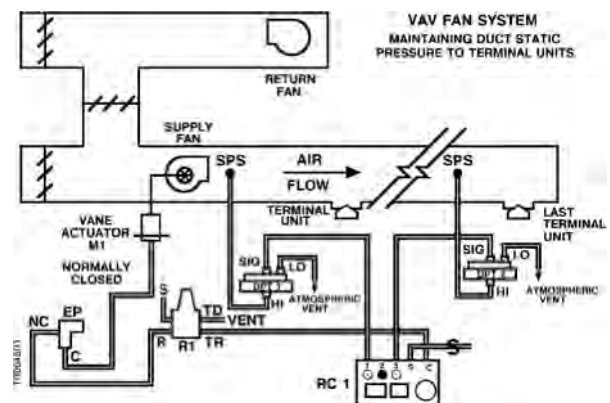

Typical Application of Duct Static Pressure Control

## 141 Specifications

**Action** ..... Direct

**Input (Supply) Air Pressure**

Normal..... 20 psi (138 kPa)

Maximum..... 30 psi (207 kPa)

**Overpressure in HI and LO Ports** .....30" W.G. (7.5 kPa)

**Output Pressure<sup>1</sup>** ..... 3 to 15 psi (21 to 103 kPa)

**Air Consumption** ..... 35 scim (9.6 ml/s)

**Operating Ambient Temperature**

Minimum..... 40°F (4°C)

Maximum..... 140°F (60°C)

1. Linear for differential pressure inputs. Nonlinear for velocity. Refer to the velocity conversion chart on the following page for more details.

**Calibration** .....Zero adjust

**Accuracy**

Full Range..... ±5% full scale

Mid Range..... ±2% full scale

**Air Connections**

Sensing Line..... 3/8" (10 mm) OD polyethylene

Supply Air ..... 1/4" (6 mm) OD polyethylene

**Maximum Sensing Line Length**

1/4" (6 mm) OD polyethylene.....200 ft. (61 m)

3/8" (10 mm) OD polyethylene..... 500 ft. (152 m)

**Materials** .....ABS plastic body and rubber diaphragm

**Mounting** .....Horizontal only

**Dimensions** ..... 2.69" H x 5.31" W x 5.56" D  
(68 mm H x 135 mm W x 141 mm D)

**Shipping Weight** .....0.5 lb. (0.23 kg)

## 141 Product Ordering

Differential Input Pressure	Part No.
-0.05 to +0.2" W.G. (-12 to +50 Pa)	<b>141-0590</b>
-0.5 to +0.5" W.G. (-125 to +125 Pa)	<b>141-0591</b>
0 to 3" W.G. (0 to 750 Pa)	<b>141-0592</b>
0 to 10" W.G. (0 to 2.5 kPa)	<b>141-0593</b>

## 141 Accessories Product Ordering

Control Symbol	Description	Part No.
DPT1	141 Low Differential Pressure Transmitter 0 to 10" W.G. (0 to 2.5 kPa)	<b>141-0593</b>
DPT2	141 Low Differential Pressure Transmitter 0 to 3" W.G. (0 to 750 kPa)	<b>141-0592</b>
SPS	Static Pressure Sensor (2 required)	<b>269-062</b>
RC1	195 Receiver-Controller	<b>195-0003</b>
G2	2-1/2" Receiver Gauge - 0 to 3" W.G.	<b>142-0266</b>
M1	Fan Vane Actuator	<b>as req.</b>
R1	Multi-purpose (reversing) Relay	<b>243-0009</b>

# 141 Engineering Diagrams

Typical Static Pressure Differential Control

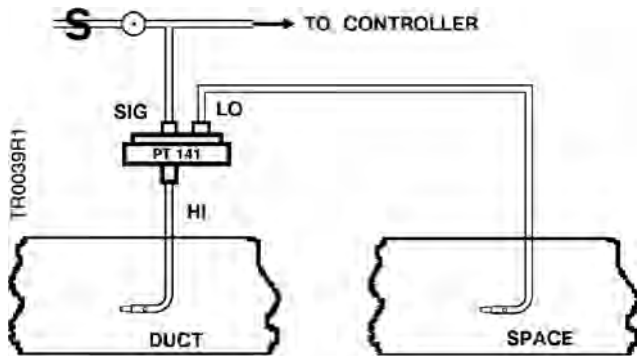

Typical Differential Velocity Pressure Control

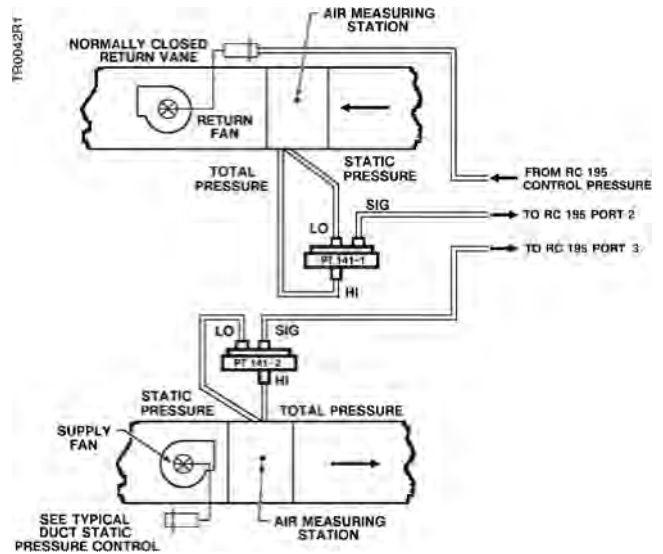

Typical Static Pressure Control

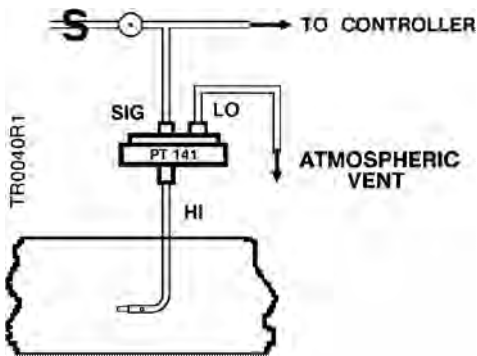

Velocity Pressure Control is recommended when the supply fan does not exceed 25,000 CFM (11,800 l/s) and the downturn ratio (min./max. return fan CFM) does not exceed 0.5 (0.2 l/s).

*Example:* If the return fan CFM varies from 8,000 to 20,000 CFM (3,776 to 9,440 l/s), the turndown ratio is 0.4 (0.2 l/s). The 141 Velocity Pressure Transmitter, with square root extractor, is recommended for these conditions.

Typical Velocity Pressure<sup>1</sup> Indication

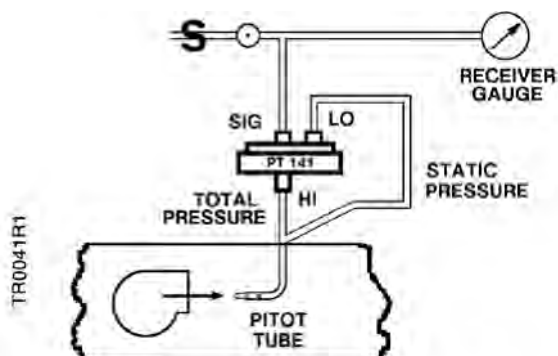

VELOCITY PRESSURE = TOTAL PRESSURE - STATIC PRESSURE

1. Allow 10 duct diameters of straight duct before (and 4 duct diameters after) the pitot tube to provide laminar air flow.

Standard Pitot Tube

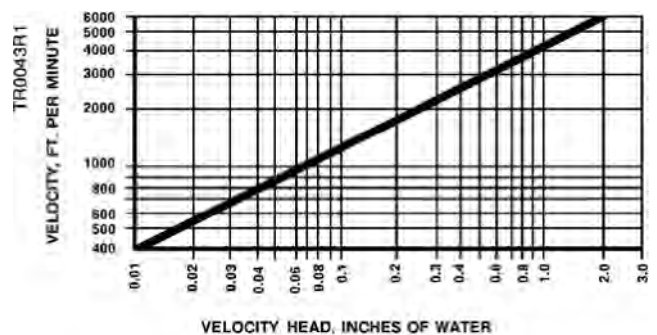

This chart illustrates the relationship between velocity and velocity head for standard air.

# Receiver Gauges



142 Pneumatic Receiver Gauges.

## Description

Used for visual indication of the value of a variable required to report system or functional operating status, Receiver Gauges are available as 1-1/2-inch (38 mm), 2-1/2-inch (64 mm), and 3-1/2-inch (89 mm) diameter gauges with a barb fitting for 1/4-inch (6 mm) OD polyethylene tubing.

## Features

- Easy-to-read dials
- Available in variety of control ranges

## Applications

Receiver Gauges are mounted on a central control panel and respond to pneumatic signals from a remotely located transmitter used to measure temperatures, humidity, and pressures of mechanical equipment.

C-15

Controllers & Transmitters

### Application Drawing

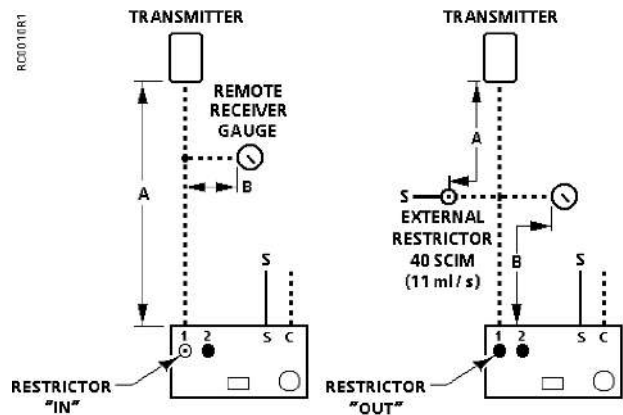

DISTANCE "A" NOT TO EXCEED 300 FEET (92 m)  
 DISTANCE "A" + "B" NOT TO EXCEED 1000 FEET (306 m)



# Static Pressure and Liquid Level Regulators



269 Static Pressure and Liquid Level Regulator.

## Description

The 269 Static Pressure and Liquid Level Regulator is a direct acting, pneumatic differential controller that measures static or head pressure, and is used to directly control inlet vanes, damper actuators, or similar devices.

## Features

- Removable restriction for ease of servicing
- Integral mounting bracket for horizontal mounting
- Adjustable setpoint
- Many models available covering a wide range of pressures

## Applications

### 269 Static Pressure Regulator

The 269 Static Pressure Regulator can be used to control velocity, static, or differential pressure to pneumatically control a damper or similar device.

### 269 Liquid Level Regulator

The 269 Liquid Level Regulator is used to maintain liquid level in an industrial process by pneumatically controlling a valve.

### Application Drawings

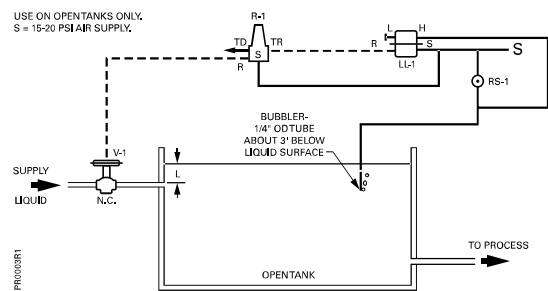

Typical Application of Liquid Level Regulation

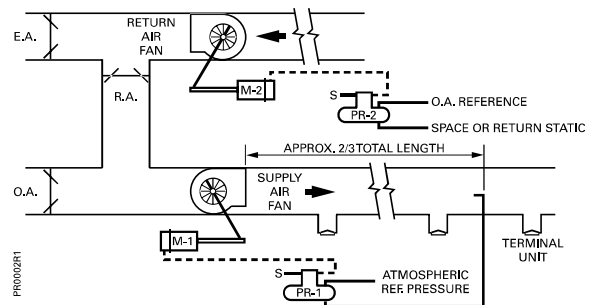

PR-1&2 269SP STATIC PRESSURE REGULATOR  
M-1&2 INLET VANE OPERATOR

Typical Application of Static Pressure

C-17

Controllers & Transmitters

## 269 Regulators Specifications

**Control Action** ..... Direct

**Supply Pressure**  
 Normal..... 20 psi (140 kPa)  
 Maximum..... 30 psi (207 kPa)

**Maximum Ambient Temperature** ..... 120°F (50°C)

**Maximum Allowable Pressure**  
 "H" and "L" Port ..... 10" W.G. (2.5 kPa) Differential

**Number of Turns for Setpoint Change of 1" W.G.**  
 269-1066 ..... approx. 6 turns  
 269-1067 ..... approx. 1/2 turn  
 269-1068 ..... approx. 6 turns  
 269-1069 ..... approx. 1/4 turn

**Response**  
 269-1066, 269-1067, 269-1068..... 0.005" W.G. (1.2 Pa)  
 269-1069 ..... 0.01" W.G. (2.5 Pa)

**Air Connections** ..... Barb fitting for 1/4" (6 mm) OD polyethylene tubing

**Dimensions** ..... 3.125" H x 3.25" W x 3.31" D  
 (79 mm H x 83 mm W x 84 mm D)

**Shipping Weight** ..... 1.5 lb. (0.07 kg)

## 269 Regulators Product Ordering

Differential Range	Sensitivity (Fixed)	Mounting Position	Part No.
0.05 to 1.00" W.G. (12 to 249 Pa) 0.20 to 1.00" W.G. (50 to 249 Pa)	2.25 psi/0.01" W.G. (6.2 kPa/Pa) 40 scim restrictor	Upright Upside Down	<b>269-1066</b>
0.05 to 3.00" W.G. (12 to 746 Pa) 0.20 to 3.00" W.G. (50 to 746 Pa)	1 psi/0.01" W.G. (2.8 kPa/Pa) 40 scim restrictor	Upright Upside Down	<b>269-1067</b>
0.05 to 1.00" W.G. (12 to 249 Pa) 0.20 to 1.00" W.G. (50 to 249 Pa)	2.25 psi/0.01" W.G. (6.2 kPa/Pa) 80 scim restrictor	Upright Upside Down	<b>269-1068</b>
Liquid Level <sup>1</sup> 1.00 to 8.00" W.G. (250 to 1990 Pa)	1 psi/0.1" W.G. (0.3 kPa/Pa) 40 scim restrictor	Upright Upside Down	<b>269-1069</b>

**Ordering Note**

1. This is not a differential range; "H" and "L" ports are internally connected.

C-18

Controllers & Transmitters



## Accessories &amp; Service Kits





## Table of Contents

PRODUCT	PAGE #
<b>Direct Mount Controller</b>	
Immersion Well	C-20
<b>Pneumatic Controllers</b>	
Pneumatic Spring Clamp	C-20
<b>185/195 Receiver-Controllers</b>	
Simulator	C-20
Tools	C-21
Replacement Scales	C-21
Connectors/Restrictors	C-21
Termination Strips	C-21
Replacement Parts	C-21
<b>184 Temperature Transmitters</b>	
Restrictors	C-22
Wells/Well Mounting Kit	C-22
Bulb Shields	C-22
Replacement Parts	C-22
<b>141 Air Velocity Transmitters</b>	
Restrictors	C-23
Probes	C-23

C-19

Controllers &amp; Transmitters

## Accessories & Service Kits







	Description	Product Group	Quantity	Part No.
<b>Direct Mount Controller</b>				
	<b>Immersion Well.</b> 1/2" NPT x 6" long	Direct Mount Controllers	1	<b>ARG150U</b>
<b>All Pneumatic Products</b>				
	<b>Pneumatic Spring Clamp.</b>	All	1	<b>531-833</b>
<b>185/195 Receiver-Controllers</b>				
	<b>185/195 Receiver-Controller Simulator.</b> Used for setup and calibration. Comes complete with a carrying case and the following parts:			
	• One gauge/switch assembly	185, 195	1	<b>195-098</b>
	• Two gauge/switch assemblies	185, 195	1	<b>195-099</b>
	• Three gauge/switch assemblies	185, 195	1	<b>195-100</b>
	<b>Receiver-Controller Calibration Slide Rule.</b> Used to calculate proportional band and control point authority.	185, 195	1	<b>153-054</b>
	<b>Calibration Card.</b> Shows transmitter pressures for various analog ranges to assist in calibration.	185, 195	1	<b>144-022</b>

C-20

Controllers & Transmitters

53











## Accessories & Service Kits

	Description	Product Group	Quantity	Part No.																																																															
<b>185/195 Receiver-Controllers</b>																																																																			
 <p><b>Ordering Notes</b></p> <ul style="list-style-type: none"> <li>• Add Scale ID as suffix to Part No.</li> <li>• Indicate English or Metric units.</li> </ul>	<b>Setpoint Dial Sheets.</b> Direct Acting and Reverse Acting.	195	4 Sheets	<b>195-130</b>																																																															
	<table border="1"> <thead> <tr> <th>English Units</th> <th>Metric Units</th> <th>Scale ID</th> </tr> </thead> <tbody> <tr> <td>-40 to +120°F</td> <td>-40 to +50°C</td> <td><b>A</b></td> </tr> <tr> <td>50 to 100°F</td> <td>10 to 38°C</td> <td><b>B</b></td> </tr> <tr> <td>80 to 240°F</td> <td>26 to 117°C</td> <td><b>C</b></td> </tr> <tr> <td>20 to 80% RH</td> <td>-18 to +38°C</td> <td><b>D</b></td> </tr> <tr> <td>0 to 100°F</td> <td>1 to 58°C</td> <td><b>E</b></td> </tr> <tr> <td>35 to 135°F</td> <td>0 to 750 Pa</td> <td><b>F</b></td> </tr> <tr> <td>0 to 3 W.G.</td> <td>0 to 3.75 kPa</td> <td><b>G</b></td> </tr> <tr> <td>0 to 15 W.G.</td> <td>20 to 80% RH</td> <td><b>H</b></td> </tr> <tr> <td>0 to 0.5 W.G.</td> <td>0 to 125 Pa</td> <td><b>J</b></td> </tr> <tr> <td>Blank 10 divisions</td> <td>Blank 9 divisions</td> <td><b>K (DA)</b></td> </tr> <tr> <td>Blank 16 divisions</td> <td>Blank 11 divisions</td> <td><b>K (RA)</b></td> </tr> <tr> <td>-0.05 to ±0.2" W.G.</td> <td>-12.5 to +50 Pa</td> <td><b>L</b></td> </tr> <tr> <td>-0.5 to +0.5" W.G.</td> <td>-125 to +125 Pa</td> <td><b>M</b></td> </tr> <tr> <td>0 to 10" W.G.</td> <td>0 to 2.5 kPa</td> <td><b>N</b></td> </tr> <tr> <td>Blank 20 divisions</td> <td>Blank 15 divisions</td> <td><b>P</b></td> </tr> <tr> <td>0 to 50 psi</td> <td>0 to 345 kPa</td> <td><b>R</b></td> </tr> <tr> <td>50 to 150°F</td> <td>10 to 66°C</td> <td><b>S</b></td> </tr> <tr> <td>40 to 240°F</td> <td>4 to 116°C</td> <td><b>T</b></td> </tr> <tr> <td>-40 to +160°F</td> <td>-40 to +71°C</td> <td><b>V</b></td> </tr> <tr> <td>30 to 190°F</td> <td>-1 to +88°C</td> <td><b>W</b></td> </tr> </tbody> </table>	English Units	Metric Units	Scale ID	-40 to +120°F	-40 to +50°C	<b>A</b>	50 to 100°F	10 to 38°C	<b>B</b>	80 to 240°F	26 to 117°C	<b>C</b>	20 to 80% RH	-18 to +38°C	<b>D</b>	0 to 100°F	1 to 58°C	<b>E</b>	35 to 135°F	0 to 750 Pa	<b>F</b>	0 to 3 W.G.	0 to 3.75 kPa	<b>G</b>	0 to 15 W.G.	20 to 80% RH	<b>H</b>	0 to 0.5 W.G.	0 to 125 Pa	<b>J</b>	Blank 10 divisions	Blank 9 divisions	<b>K (DA)</b>	Blank 16 divisions	Blank 11 divisions	<b>K (RA)</b>	-0.05 to ±0.2" W.G.	-12.5 to +50 Pa	<b>L</b>	-0.5 to +0.5" W.G.	-125 to +125 Pa	<b>M</b>	0 to 10" W.G.	0 to 2.5 kPa	<b>N</b>	Blank 20 divisions	Blank 15 divisions	<b>P</b>	0 to 50 psi	0 to 345 kPa	<b>R</b>	50 to 150°F	10 to 66°C	<b>S</b>	40 to 240°F	4 to 116°C	<b>T</b>	-40 to +160°F	-40 to +71°C	<b>V</b>	30 to 190°F	-1 to +88°C	<b>W</b>			
	English Units	Metric Units	Scale ID																																																																
	-40 to +120°F	-40 to +50°C	<b>A</b>																																																																
	50 to 100°F	10 to 38°C	<b>B</b>																																																																
	80 to 240°F	26 to 117°C	<b>C</b>																																																																
	20 to 80% RH	-18 to +38°C	<b>D</b>																																																																
	0 to 100°F	1 to 58°C	<b>E</b>																																																																
	35 to 135°F	0 to 750 Pa	<b>F</b>																																																																
	0 to 3 W.G.	0 to 3.75 kPa	<b>G</b>																																																																
	0 to 15 W.G.	20 to 80% RH	<b>H</b>																																																																
	0 to 0.5 W.G.	0 to 125 Pa	<b>J</b>																																																																
	Blank 10 divisions	Blank 9 divisions	<b>K (DA)</b>																																																																
	Blank 16 divisions	Blank 11 divisions	<b>K (RA)</b>																																																																
	-0.05 to ±0.2" W.G.	-12.5 to +50 Pa	<b>L</b>																																																																
	-0.5 to +0.5" W.G.	-125 to +125 Pa	<b>M</b>																																																																
	0 to 10" W.G.	0 to 2.5 kPa	<b>N</b>																																																																
Blank 20 divisions	Blank 15 divisions	<b>P</b>																																																																	
0 to 50 psi	0 to 345 kPa	<b>R</b>																																																																	
50 to 150°F	10 to 66°C	<b>S</b>																																																																	
40 to 240°F	4 to 116°C	<b>T</b>																																																																	
-40 to +160°F	-40 to +71°C	<b>V</b>																																																																	
30 to 190°F	-1 to +88°C	<b>W</b>																																																																	
 <p><b>Receiver-Controller Restriction Kit.</b> Includes three input restriction plates, one pilot relay restriction plate, gaskets, and two screws.</p>	195	1 Kit	<b>195-066</b>																																																																
 <p><b>Receiver-Controller Connector Kit.</b> Includes two plug-in connector assemblies, one 3-barb input connector assembly.</p> <ul style="list-style-type: none"> <li>• Multiple-Input</li> </ul>	195	1 Kit	<b>195-067</b>																																																																
 <p><b>Termination Strip.</b> For numbered ports 1 through 10, straight through connections for 1/4" (6 mm) OD polyethylene tubing.</p>	195	1	<b>195-082</b>																																																																
 <p><b>Pressure Gauge.</b> Dual Scale 0 to 30 psig (0 to 200 kPa ) 12" NPT male thread (back)</p>	184, 195	1	<b>142-0373</b>																																																																
 <p><b>In-Line Air Filter.</b></p>	195	1	<b>908-033</b>																																																																

C-21

Controllers & Transmitters

## Accessories & Service Kits



	Description	Temperature Range	Part No.	
<b>184 Temperature Transmitters</b>				
	<b>Rigid Bulb Transmitter.</b> Bulb 1/4" Dia. x 9" L (6 mm Dia. x 229 mm L)	35 to 135°F (2 to 57°C)	<b>184-0001</b>	
		50 to 100°F (10 to 38°C)	<b>184-0002</b>	
		80 to 240°F (27 to 116°C)	<b>184-0003</b>	
		0 to 100°F (-18 to +38°C)	<b>184-0028</b>	
	<b>Remote Averaging Bulb Transmitter.</b> 3/32" Dia. x 20' L (2 mm Dia. x 6.1 m L) with 12" (305 mm) Capillary	35 to 135°F (2 to 57°C)	<b>184-0004</b>	
		0 to 100°F (-18 to +38°C)	<b>184-0048</b>	
	<b>Remote Bulb Transmitter.</b> 1/4" Dia. x 4" L (6 mm Dia. x 102 mm L) 3' (0.92 m) Capillary	-40 to +120°F (-40 to +49°C)	<b>184-0005</b>	
		50 to 100°F (10 to 38°C)	<b>184-0018</b>	
		80 to 240°F (27 to 116°C)	<b>184-0014</b>	
		0 to 100°F (-18 to +38°C)	<b>184-0036</b>	
		-10 to +65°F (-23 to +18°C)	<b>184-0015</b>	
		35 to 135°F (2 to 57°C)	<b>184-0034</b>	
		30 to 190°F (-1 to +88°C)	<b>184-0041</b>	
	Description	Product Group	Quantity	Part No.
	<b>Remote Bulb Transmitter.</b> 1/4" Dia. x 4" L (6 mm Dia. x 102 mm L) 3' (0.92 m) Armored Capillary	184	1	<b>184-0006</b>
	<b>Room Transmitter.</b> With cover and wall plate ( <b>180-443</b> )	184	1	<b>184-0340</b>
	<b>Restrictor Tees.</b> 40 scim for 1/4" (6 mm) OD plastic. Required for 195 Receiver-Controller only when total transmitter line is greater than 300' (91 m) long.	184	Package of 5	<b>184-114</b>
	<b>In-line Restrictors.</b> 40 scim (11 ml/s)	184	Package of 5	<b>184-117</b>
	<b>Well Mounting Bracket Kit.</b>	184	1	<b>184-105</b>
	<b>Copper Well.</b> 1/4" D x 4" L (6 mm D x 102 mm L)	184	1	<b>184-119</b>
	<b>Stainless Steel Well.</b> 1/4" D x 4" L (6 mm D x 102 mm L)	184	1	<b>184-118</b>
	<b>Outdoor Bulb Shield.</b> 9" (229 mm) L	184	1	<b>134-084</b>

C-22

Controllers & Transmitters

53

## Accessories & Service Kits

	Description	Product Group	Quantity	Part No.
<b>141 Air Velocity Transmitters</b>				
	<b>Restrictor Tees.</b> 40 scim for 1/4" (6 mm) OD plastic. Required for 195 Receiver-Controller only when total transmitter line is greater than 300' (91 m) long.	141	Package of 5	<b>184-114</b>
	<b>Static Pressure Sensor Probe.</b>	141	1	<b>269-062</b>
	<b>Static Pressure Probe Kit.</b>	SW269	1	<b>189-142</b>

